

SERVICE MANUAL

IVL[™] dice by MINUIT[®]
UNE

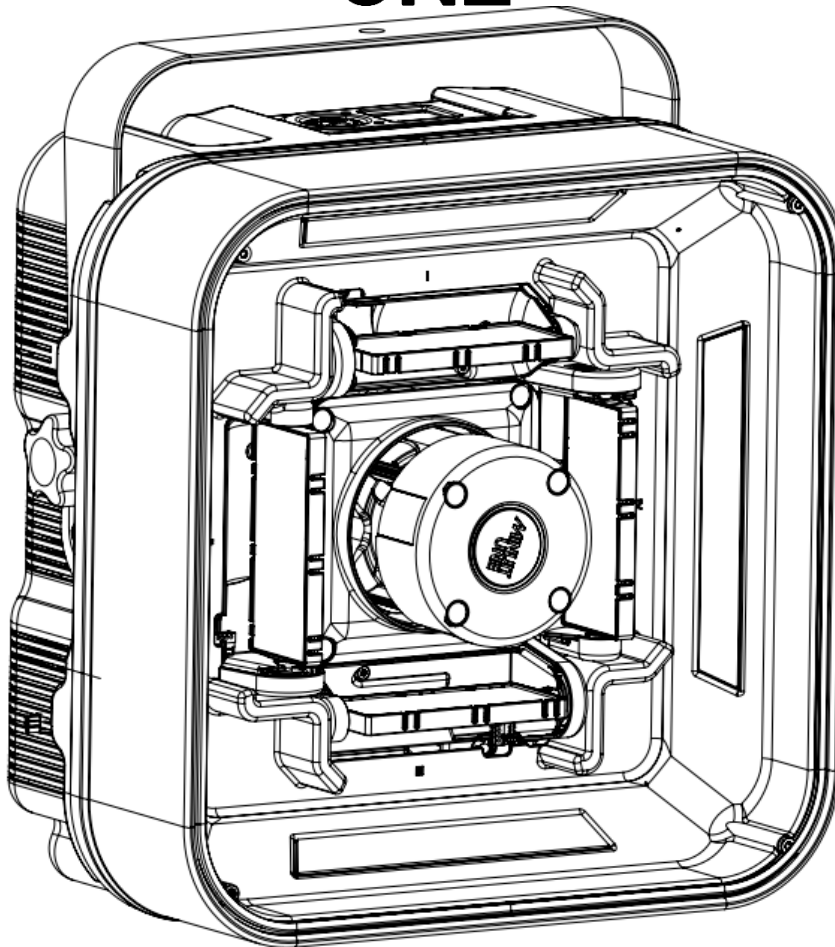

Endless excitements in a compact
housing.

© 2021 ARTEFFECT SAS – Minuit Une

All rights reserved. Information subject to change without notice. ARTEFFECT and all affiliated companies disclaim liability for any injury, damage, direct or indirect loss, consequential or economic loss or any other loss occasioned by the use of, inability to use or reliance on the information contained in this document. Minuit Une, IVL LIGHTING, IVL Dice are registered trademarks of ARTEFFECT SAS.

No part of this document may be used for distribution, reproduction, transmission, transcription, storage in a data retrieval system, or translated into any language in any form by any means without the prior written permission of ARTEFFECT. If you are downloading files from our web pages for your personal use, make sure to check for updated versions. ARTEFFECT cannot take any liability whatsoever for downloaded files, as technical data are subject to change without notice.

www.minuitune.com | 111 avenue Gaston Roussel 93230 ROMAINVILLE – FRANCE
service@minuitune.com

Table of Content

Important Safety Information	5
Risk Levels and Alert Symbols	7
Vital Precautions	8
General Safety Information	9
Intended use	10
Important Laser Information	11
Labelling diagram.....	11
1: Serial number label	12
2: MAIN MANUFACTURER LABEL	12
Before using the product	13
Dimensions	14
IVL dice and Base Dimensions.....	14
Overview	15
Front View.....	15
Bottom View.....	15
Side View	16
Spare Part list:.....	17
Tools, equipment, and accessories.....	20
Fixture menu and connectors.	22
Menu buttons	22
Display	22
Indicator LEDs	22
DMX connectors	22
Power Connectors	22
Adjustable mounting yoke	22
MAINTENANCE	26
TROUBLESHOOTING	26
PRODUCT IS NOT EMITING LIGHT OUTPUT.....	27
PRODUCT IS EMITTING UNUSUAL/ABNORMAL LIGHT	28
TILT PROBLEM	29
SERVICE OPERATION	30
REPLACING SPARE PARTS OPERATION	30
REP 1: REPLACING	31
DICE-BOTTOM-HOUSING-AND-INSERTS(MT1-002461)	31
REP 2: REPLACING	32
MOTHER-PCB-ASSEMBLY(MT1-000139)	32

REP 3: REPLACING _____	34
DICE-POWER-SUPPLY-ASSEMBLY(MT1-002789) _____	34
REP 4: REPLACING _____	36
DICE-TRANSPARENT-COVER(MT1-001645) _____	36
REP 5: REPLACING _____	38
MASK-MIRROR-AND-FROST-ASSEMBLY (MT1-002639) _____	38
REP 6: REPLACING _____	41
DICE-INTERNAL-TOP-COVER(MT1-002325) _____	41
REP 7: REPLACING _____	45
LATERAL-BELT-ACTUATOR-ASSEMBLY(MT1-000935) _____	45
REP 8: ADDRESSING LATERAL-BELT-ACTUATOR-ASSEMBLY(MT1-000935) _____	49
REP 9: REPLACING _____	51
DICE-CENTRAL-TOWER-ASSEMBLY(MT1-002787) _____	51
REP 10: REPLACING _____	56
DICE-YOKE (MT1-002354) _____	56
REP 11: REPLACING _____	64
H2-2-HARNESS-FAN(MT1-001921) _____	64
CALIBRATION	67
CAL 1: _____	67
SET UP PLATE CALIBRATION _____	67
CAL 2: _____	73
TILT CALIBRATION _____	73
CAL 3: _____	77
E-GOBO CALIBRATION _____	77
TESTING.....	81
TEST 1: _____	81
Test General _____	81
TEST 2: _____	85
Test Laser _____	85
TEST 3: _____	87
Test Tilt _____	87
TEST 4: _____	89
Test Tower _____	89
SOFTWARE UPDATE.....	91
SOF 1: _____	91
DMX UPGRADE _____	91
SOF 2: _____	93
CLEANING	95
CLE 1: _____	95
DICE-TRANSPARENT-COVER _____	95
CLE 2: _____	97
LATERAL-BELT-ACTUATOR-ASSEMBLY(MT1-000935) MASK-MIRROR-AND-FROST-ASSEMBLY(MT1-002639) _____	97
CLE 3: _____	99
DICE-CENTRAL-TOWER-ASSEMBLY(MT1-002787) _____	99
CLE 4: _____	100
FIBER-LASER-COLLIMATOR(MT1-002474) _____	100
CLE 5: _____	101
FILTER(MT1-002405),FAN(MT1-001921) and _____	101
FAN(MT1-001921) and HEATSINK _____	101
DMX Protocol	105
Specification	107
Service Return Form	1

Important Safety Information

This service Manual contains instruction about how to service Minuit Une's IVL dice product.

Service work must comply with local regulations and accepted codes of good practice.

Any person in charge of servicing this product shall have receive a service training by Minuit Une and/or by an official training center recognized by Minuit Une.

Read and understand all safety information and procedure in this service manual, and in the IVL dice user manual before servicing or cleaning this product.

Failure to respect service procedure may cause damage that is not covered by product warranties.

Any procedure or work on the product which is not described in this manual is not covered by product warranties.

Always turn off and disconnect the product from power before removing the plexiglas shape or opening the product or performing procedures of service.

1. Read these instructions.
2. Keep these instructions.
3. Heed all warnings.
4. Follow all instructions.
5. Do not use this apparatus near water.
6. Clean only with dry cloth.
7. Do not block any ventilation openings. Install in accordance with the manufacturer's instructions.
8. Do not install near heat sources such as radiators, heat registers, stoves, or other apparatus (including amplifiers) that produce heat.
9. Do not defeat the safety purpose of the grounding-type plug. A grounding type plug has two blades and a third grounding prong. The wide blade or the third prong are provided for your safety. If the provided plug does not fit into your outlet, consult an electrician for replacement of the obsolete outlet.
10. Protect the power cord from being walked on or pinched particularly at plugs, convenience receptacles, and the point where they exit from the apparatus.
11. Only use the attachment/accessories specified by the manufacturer.
12. Use only with the cart, stand, tripod, bracket, or table specified by the manufacturer, or sold with the apparatus. When a cart is used, use caution when moving the cart/apparatus combination to avoid injury from tip-over.
13. Unplug this apparatus during lightning storms or when unused for long periods of time.

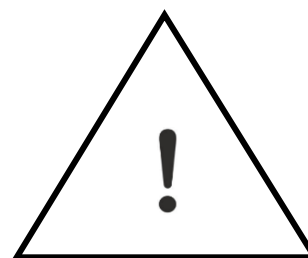

14. Refer all servicing to qualified service personnel. Servicing is required when the apparatus has been damaged in any way, such as power-supply cord or plug is damaged, liquid has been spilled, or objects have fallen into the apparatus, the apparatus has been exposed to rain or moisture, does not operate normally, or has been dropped.
15. Changes or modifications not expressly approved by Minuit One could void the user's authority to operate the equipment.
16. This equipment has been tested and found to comply with the limits for a Class A digital device, pursuant to part 15 of the FCC Rules. These limits are designed to provide reasonable protection against harmful interference when the equipment is operated in a commercial environment. This equipment generates, uses, and can radiate radio frequency energy and, if not installed and used in accordance with the instruction manual, may cause harmful interference to radio communications. Operation of this equipment in a residential area is likely to cause harmful interference in which case the user will be required to correct the interference at his own expense.
17. The normal function of the product may be distributed by strong electromagnetic interference. If so, simply reset the product to resume normal operation by following the instruction manual.

Risk Levels and Alert Symbols

Safety warnings, safety alert symbols, and signal words in these instructions indicate different risk levels.

DANGER indicates an imminent hazardous situation which, if not avoided, **will result** in death or serious injury.

WARNING indicates a potentially hazardous situation which, if not avoided, **may result** in death or serious injury.

CAUTION indicates a potentially hazardous situation which, if not avoided, **may result** in minor or moderate injury.

NOTICE explains practices not related to physical injury. No safety alert symbol appears with this signal word.

Vital Precautions

DANGER !

High voltage! Risk of blindness, electric shock and fire.

Read and understand all safety information and operation instructions before you operate or install the product or the system.

Not observing the safety information or general rules of safety may cause injury, blindness, burn hazards, electric shock, falls and death to yourself and others or damage to equipment.

Use solely and exclusively as described in the instructions.

Using the product in any other ways than specified in this manual is not permitted and can damage the product and lead to associated risks such as short-circuit, fire, electric shock, etc.

Use of controls or adjustments or performance of procedures other than those specified herein may result in hazardous radiation exposure.

Always electrically earth the fixture. Only use TN or TT one phase power supplies and a power plug according to IEC 60309-1 or a similar national standard.

Always use a power cord connected to a socket-outlet with earthing connection.

Always check that the local AC power matches the voltage and frequency range printed on the type of label of the product before use.

Never use the cables for transportation. Never hang the product from its cables.

In case of visible or suspected damage to cables or housings, the product must not be operated any longer.

The product is not to be operated with the transparent globe not in place or if the transparent globe is in any way damaged.

The laser is never to be operated if the unit is defective or if the cover, or the Acrylic shape or seal is damaged.

Do not bypass or remove any safety feature of the product.

Any procedure or work on the product which is not described in this manual is not covered by product warranties.

Refer servicing to qualified service personal.

Any person in charge of servicing this product shall first receive service training by Minuit Une and/or by an official training center recognized by Minuit Une.

Any person in charge of servicing this product shall have read and understood all safety information and procedures in this user manual, and in the IVL Dice's service manual.

To obtain information about service training, service manual or about the closest training service center in your area, please contact Minuit Une.

General Safety Information

WARNING!

Humidity, Condensation and Moisture.

To reduce the risk of fire or electric shock, do not expose this apparatus to rain or moisture. Do not use the product for 2h when it was exposed to big temperature differences as condensed moisture may damage the product electrically when switched on.

Never expose the product to dripping water or water splashes.

Never place an object filled with liquid (e.g. a vase or a bottle filled with liquid) on the product.

Do not bend the power cable directly after the connector. Water could immerse and cause short circuits and damage the connector.

Never use oil base smoke machine. Oil can cause short circuit on electronic part of the product.

WARNING!

Risk of electric shock and fire.

Socket outlets or external power switches used to supply the product with power must be located near the product and easily accessible to be able to isolate the product from power immediately.

The power cable must be equipped with a Neutral Powercon TRUE1 NAC3FX-W-TOP cable connector. You can install a suitable power plug on the power cord. Always use a power plug according to IEC 60309-1 or a similar national standard.

Disconnect the product from AC power before moving it or cleaning it.

To link several products to one power chain, please observe:

- This fixture has a maximal power consumption of 200W (for one unit)
- Always use an AWG 14 power input cable and AWG 14 power throughput cables.
- Never link more than 10 products to a power chain when using these cables.

Ensure that the airflow around the product is free and unobstructed.

Provide a minimum clearance of 0,3 m (1 in.) around fans and air vents.

No flame source, like a candlelight, should be placed on or nearby the product.

This product is intended to be used in temperate climate.

Do not operate the product if the ambient temperature is above 40° C (104° F) or below 0° C (32° F).

WARNING!

Risk of injury and damage through falls.

Always install the product as described in this manual.

Always follow the safety information when suspending the product. Always use a secondary attachment as described in this manual to prevent falls if the primary attachment fails.

Block access area during installation of the product due to risk of injury through fall.

Always work from a stable platform.

CAUTION!

Class 3R laser product according to IEC 60825-1:2014

Avoid direct eye exposure.

Avoid direct camera exposure.

Do not look at laser devices with magnifiers, telescopes, binoculars, or similar optical instruments that may concentrate the light output.

Please refer to ANSI Z136.1 "Standard for Safe Use of Lasers" for guidance on safe use. This publication is available from Laser Institute of America.

Extended source considered for laser Classification.

Note that the national and local recommendations, regulations, standards and codes of practice in laser show are different from a country to another.

Please contact your provider or Minuit Une's legal service if you have any inquiries.

Intended use

NOTICE

This product is intended for indoor use only.

This product is intended to produce lighting effects in a dry environment at an ambient temperature below 40° C (104° F) and above 0° C (32° F).

This product is intended to be use in haze environment for maximizing effect. The use of haze machine with neutral fluid like MDG ATMe is recommended to maximize lifetime of the product. On the contrary the use of oil-based smoke machine is to avoid and will cause damage to the product on long term. **Warranty will be void if excess oil is found in the product due to insufficient cleaning.**

Avoid direct camera exposure.

This product fulfills national and international legal requirements.

Important Laser Information

Procedures that could allow access to Class 4 levels of radiation include the following:

All the procedure which can be done by opening the product:

- REP1:REPLACING DICE-BOTTOM-HOUSING-AND-INSERTS (MT1-002461)
- REP2:REPLACING MOTHER-PCB-ASSEMBLY(MT1-000139)
- REP3:REPLACING DICE-POWER-SUPPLY-ASSEMBLY (MT1-002789)
- REP4:REPLACING DICE-TRANSPARENT-COVER(MT1-001645)
- REP5:REPLACING MASK-MIRROR-AND-FROST-ASSEMBLY(MT1-002639)
- REP6:REPLACING DICE-INTERNAL-TOP-COVER (MT1-002325)
- REP7:REPLACING LATERAL-BELT-ACTUATOR-ASSEMBLY (MT1-000935)
- REP8:REPLACING ADRESSING LATERAL-BELT-ACTUATOR-ASSEMBLY (MT1-000935)
- REP9:REPLACING DICE-CENTRAL-TOWER-ASSEMBLY (MT1-002787)
- REP 11: REPLACING H2-2-HARNESS-FAN(MT1-001921)
- CAL1:SET UP PLATE CALIBRATION
- CLE1: DICE-TRANSPARENT-COVER(MT1-001645)
- CLE2: LATERAL-BELT-ACTUATOR-ASSEMBLY(MT1-000935) MASK-MIRROR-AND-FROST-ASSEMBLY (MT1-002639)
- CLE3: DICE-CENTRAL-TOWER-ASSEMBLY (MT1-002787)
- CLE4: FIBER-LASER-COLLIMATOR (MT1-002474)
- CLE5: Ventilation system FILTER-COVER(MT1-002406), FILTER(MT1-002405), FAN(MT1-001921) and HEATSINK-BBQ-HYBRID(MT1-002546)

To avoid increase accessible emission level of radiation during the procedure listed above, you should always turn off and disconnect the product from power before removing the plexiglas COVER or opening the product. This will be regularly recall in this manual with the following label:

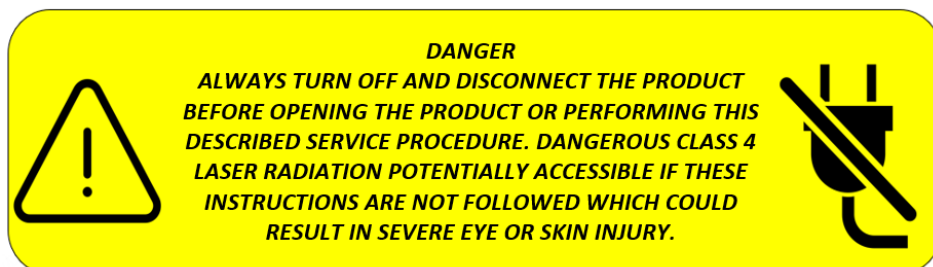

Labelling diagram

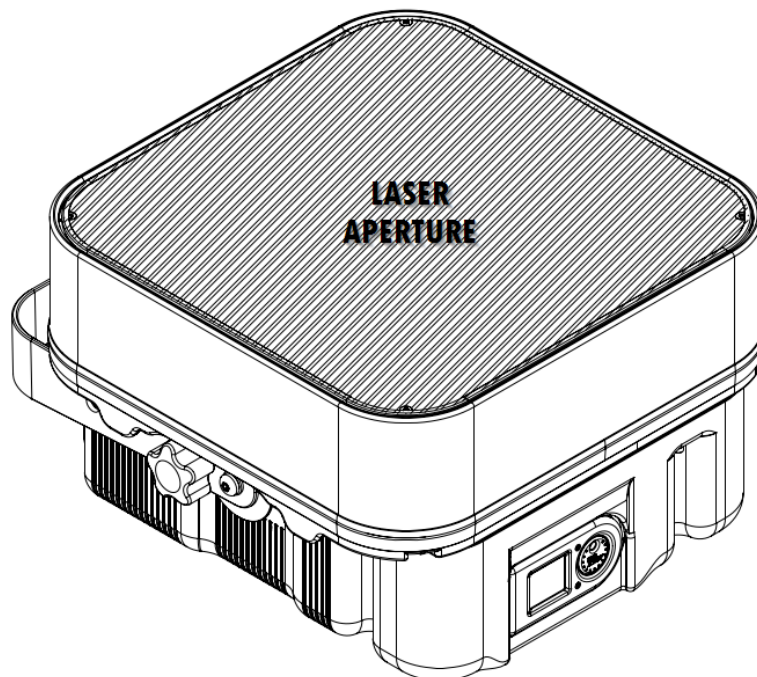
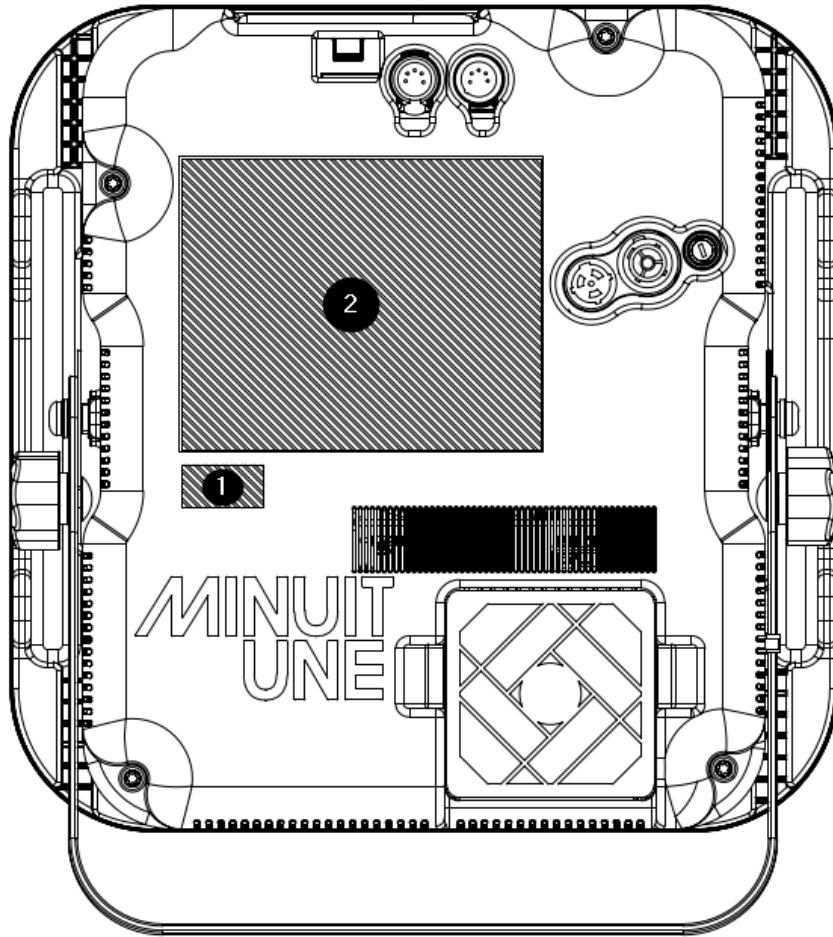

1: Serial number label



2: MAIN MANUFACTURER LABEL

IVL™ dice

by MINUIT UNE®

BRAND/MARQUE: **MINUIT UNE**
 MODEL/MOĐELE: **IVL™ dice**
 READ CAREFULLY THE MANUAL AND INSTRUCTIONS BEFORE OPERATING THIS PRODUCT.
 LISEZ ATTENTIVEMENT LE MANUEL ET LES INSTRUCTIONS AVANT D'UTILISER CE PRODUIT.
 MINUIT UNE IS A BRAND OWNED BY ARTEFFECT SAS.
 MINUIT UNE EST UNE MARQUE APPARTENANT Á ARTEFFECT SAS.

111 AVENUE GASTON ROUSSEL, BÁTIMENT RAULIN
 93230 ROMAINVILLE - FRANCE

US Pat. No. US 9,618,173
 US Pat. No. US 11,815,233

MADE IN FRANCE

THIS DEVICE COMPLIES WITH PART 15 OF THE FCC RULES. OPERATION IS SUBJECT TO THE FOLLOWING TWO CONDITIONS: (1) THIS DEVICE MAY NOT CAUSE HARMFUL INTERFERENCE, AND (2) THIS DEVICE MUST ACCEPT ANY INTERFERENCE RECEIVED, INCLUDING INTERFERENCE THAT MAY CAUSE UNDESIREĐ OPERATION.

CET APPAREIL EST CONFORME Á LA PARTIE 15 DE LA NORME FCC POUR LES ETATS-UNIS AINSI QU'Á LA NORME CANADIENNE ICES/NMB-003. L'UTILISATION DE CET APPAREIL (1) NE DOIT PAS PROVOQUER D'INTERFERENCE ET (2) TOLERE LES INTERFERENCES EXTERNES, Y COMPRIS CELLES POUVANT PROVOQUER UN FONCTIONNEMENT ANORMAL DE L'APPAREIL.

LASER APERTURE
ON TOP
OUVERTURE LASER
AU DESSUS

LASER LIGHT AVOID DIRECT EYE EXPOSURE
CLASS 3R LASER PRODUCT
RAYONNEMENT LASER
EXPOSITION DIRECTE DANGEREUSE POUR LES YEUX
APPAREIL Á LASER DE CLASSE 3R
450nm, 520nm, 638nm 330Hz, <38 μJ
EN/IEC 60825-1 ed. 3 2014

THIS PRODUCT COMPLIES WITH FDA PERFORMANCE STANDARDS FOR LASER PRODUCTS EXCEPT FOR CONFORMANCE WITH IEC 60825-1 ED.3. AS DESCRIBED IN LASER NOTICE NO. 56, DATED MAY 8, 2019.

WARNING: TO REDUCE THE RISK OF FIRE OR ELECTRIC SHOCK DO NOT EXPOSE THIS EQUIPMENT TO RAIN OR MOISTURE.
AVERTISSEMENT : NE PAS EXPOSER CE MATERIEL Á LA PLUIE OU L'HUMIDITE AFIN DE REDUIRE LE RISQUE D'INFLAMMATION OU BIEN DE CHOC ELECTRIQUE.

INPUT : 100-240 V~ / 50/60Hz / 2 000 W max
OUTPUT : 100-240 V~ / 1 800 W max
FUSE : T6.3AH250V

1 UNIT : 200 W max

WARNING: SHOCK HAZARD - DO NOT OPEN.
AVERTISSEMENT: RISQUE DE CHOC ELECTRIQUE - NE PAS OUVRIR.

DANGER CLASS 4 LASER LIGHT WHEN OPENING THE FIXTURE FOR SERVICE. AVOID EYE OR SKIN EXPOSURE TO DIRECT OR SCATTERED RADIATION.

Before using the product

1. Read the “Important Safety Information” on page 5 before doing anything with the product.
2. Unless explicitly stated by Minit Une, do not dismantle the modules, as **this will invalidate the warranty**.
3. Damages resulting from improper handling of the product, insufficient cleaning, or from transportation arranged by the customer, **are not covered by the warranty of the product**.
4. Unpack and ensure that there is no transportation damage before using the product. Do not attempt to operate a damaged product.
5. Check that no part shipped with the product is missing. The product is shipped with:
 - A Neutrik Powercon TRUE1 connector NAC3FX-W-top
 - A page with a QR code to download the user manual.
6. Install the neutrik powercon TRUE1 connector on an AWG 14 power cable with a power plug according to your local electrical regulation.
7. Ensure that the voltage and frequency of the power supply match the power requirements of the product.

Note that whenever AC power is applied to the product, it will reset all effects and functions to their home positions. A reset usually takes approximately 10 seconds .

Dimensions

IVL dice and Base Dimensions

All dimensions are given in millimeters.

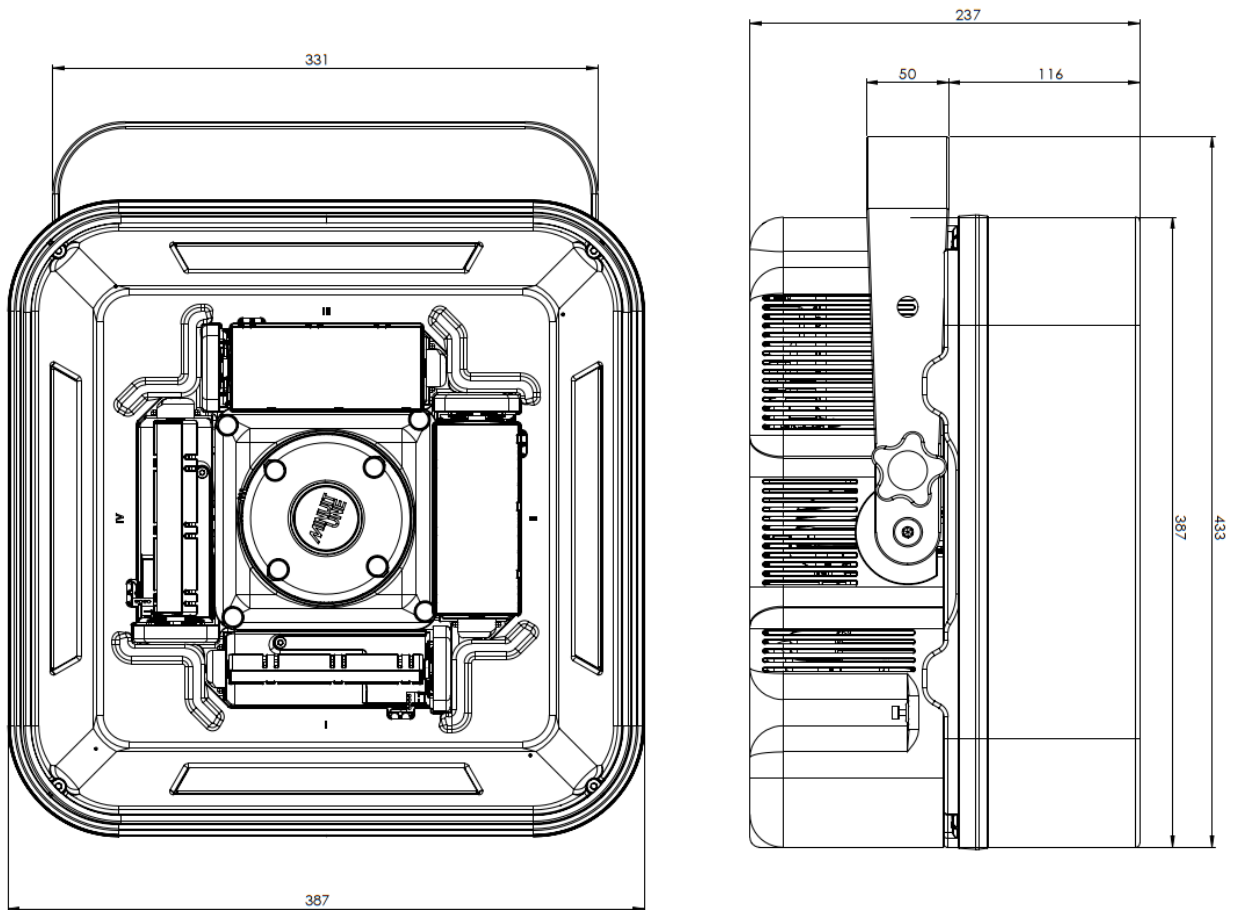

Overview

Front View

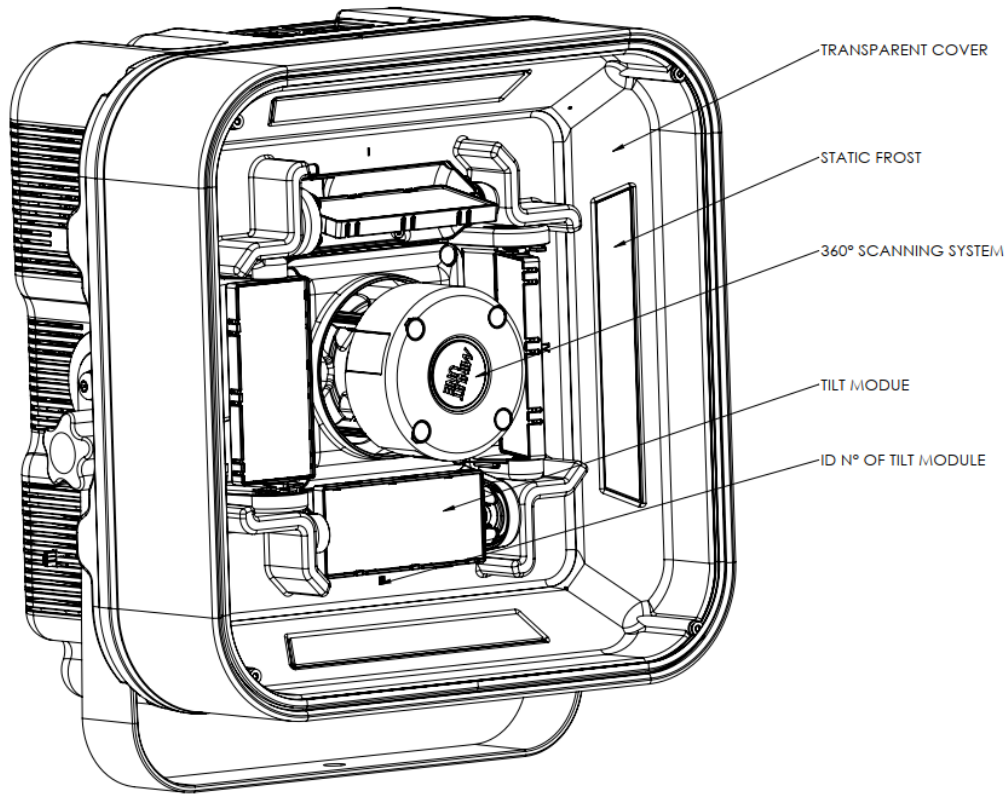

Bottom View

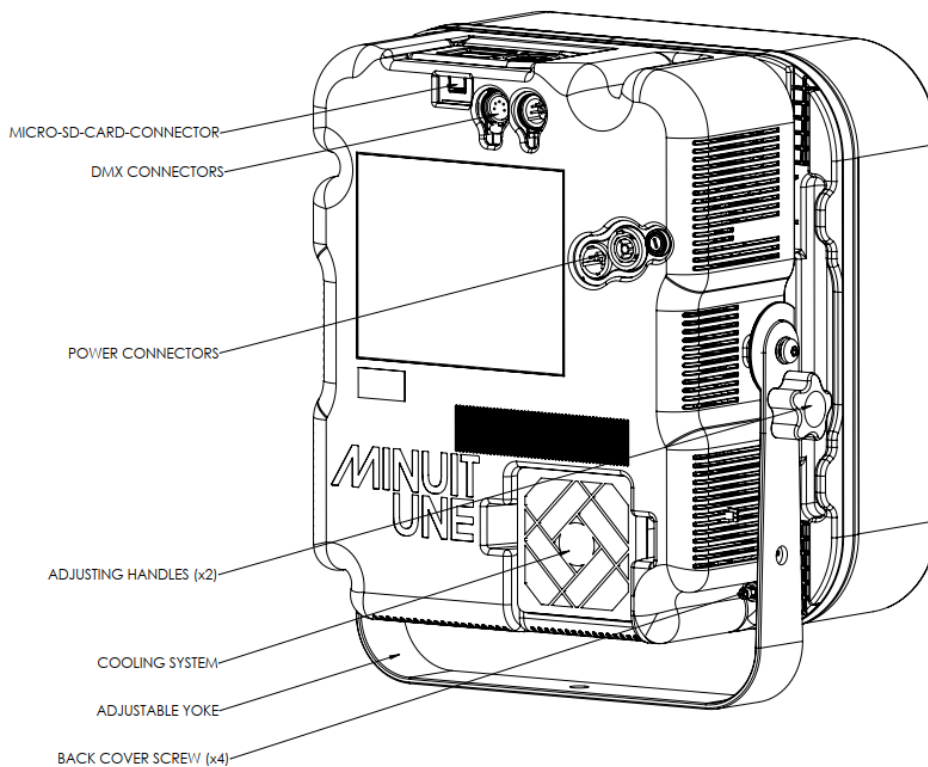

Side View

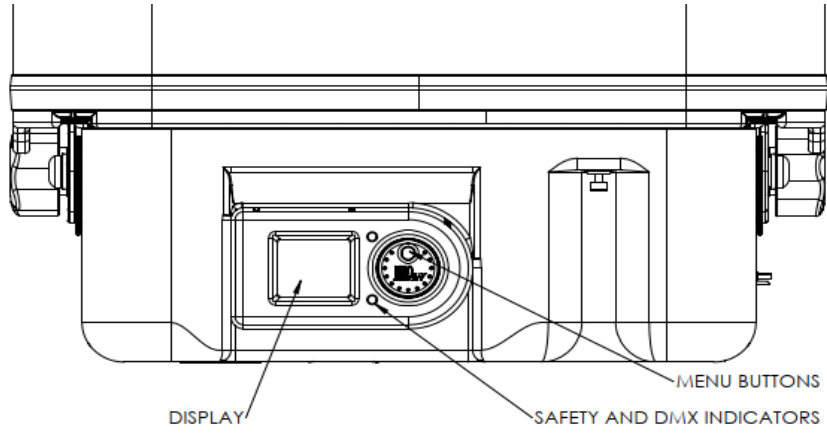

Spare Part list:











PART NUMBER	DESCRIPTION	IMAGE	SECTION
MT1-001057	MAIN-HOUSING-LATERAL-SEAL		REP 7:
MT1-001037	CONNECTOR-SEAL		REP 7:
MT1-001699	SCREW-M4-8-TORX		REP 7:
MT1-002789	DICE-POWER-SUPPLY-ASSEMBLY		REP 3:
MT1-000139	MOTHER-PCB-ASSEMBLY		REP 2,8,9 : SOF 1,2 :
MT1-000614	CENTRAL-TOWER-SEAL		REP 9:
MT1-002508	SCREW-M6-40-TORX		REP 2:
MT1-000656	SCREW-M3-20-TORX		REP 6:
MT1-002461	DICE-BOTTOM-HOUSING-AND-INSERTS		REP 1,2,3,4,5,6, 7,8,11:, CLE 5:
MT1-002405	FILTER		REP 11 : CLE 5 :
MT1-002406	FILTER-COVER		REP 11 : CLE 5 :
MT1-002325	DICE-INTERNAL-TOP-COVER		REP 6,7,9 :
MT1-002765	FRICITION-PLATE-AND-HOOP-FIXTURE-SUPPORT-ASSEMBLY		REP 10:
MT1-002423	YOKE-SPACER		REP 10:
MT1-001659	DICE-MAIN-HOUSING-AND-INSERTS		REP 5,6,8,9:
MT1-002354	DICE-YOKE		REP 1: REP 10:
MT1-002425	KNOB-M8-THREADED-HOLE		REP 10:
MT1-002422	SQUARE-NECK-BOLT-M8-16		REP 10:





MT1-003031	SCREW-M8-16-TORX-ROUNDED		REP 10:
MT1-003032	CONTACT-WASHER-M8-L		REP 10:
MT1-002288	SCREW-M6-20-TORX		REP 3:
MT1-003029	SCREW-M6-35-TORX		REP 3:
MT1-002543	SCREW-M6-30-TORX		
MT1-002639	MASK-MIRROR-AND-FROST-ASSEMBLY		REP 4,5,6,7,8,9: CAL 1,2: TEST 1: CLE 2:
MT1-001921	H2-2-HARNESS-FAN		REP 11 : CLE 5 :
MT1-002404	FINGER-GUARD		REP 11 : CLE 5 :
MT1-000935	LATERAL-BELT-ACTUATOR-ASSEMBLY		REP 4,7,8: CAL 1,2,3: TEST 1,2,3: CLE 2:
MT1-002638	MIRROR-MASK-FROST		CAL 1: CAL 2:
MT1-002691	HARNESS-DI-TOWER		REP 8,9 :
MT1-002692	HARNESS-DI-LASER		REP 2:
MT1-002695	HARNESS-DI-TILT		REP 7: REP 2:
MT1-001645	DICE-TRANSPARENT-COVER		REP 4,10: CAL 1,2,3: TEST 1,2,3,4: CLE 1,2:
MT1-002314	DICE-GLOBE-SEAL		REP 4:
MT1-003041	SCREW-M4-8-FLAT-HEAD-TORX		REP 4: CAL 1: CLE 1:

MT1-002787	DICE-CENTRAL-TOWER-ASSEMBLY		REP 9: CAL 1: TEST 1,4: CLE 3:
MT1-001361	CENTRAL-CONNECTOR-MASK		
MT1-001173	SCREW-M3-35-HEX		CAL 1:
MT1-001600	CENTRAL-TOP-TOWER-SCREW-MASK		REP 6: CAL 1:
MT1-002408	M4-40-FLAT-HEAD-TORX		REP 11:
MT1-000534	SIMPLIFIED-SCREW-MASK		
MT1-001094	SCREW-M4-16-TORX		REP 9:
MT1-002696	QUARTER-TURN-TORX-T30-SCREW-3		REP 1,5 :
MT1-001090	QUARTER-TURN-SEALED-RECEPTACLE		
MT1-002360	DICE-HOUSING-SEAL		REP 5:

Tools, equipment, and accessories

Here are the different tools, equipment, and accessories necessary to service the IVL dice.
All these tools and accessories are not provided by Minuit Une.

Tool/Equipment/ accessory	Image	Section
Removable bit / Torx screwdriver T10		REP 8:
Removable bit / Torx screwdriver T15		REP 6:
Removable bit / Torx screwdriver T20		REP 4,7,9,11 :
Removable bit / Torx screwdriver T30		REP 1,2, 3,5, :
Removable bit / Torx screwdriver T40		REP 10 :
Micro SD card		SOF 1,2 :
Removable bit / Flat head screwdriver 2.5mm		REP 6:
Allen wrench 6mm		CAL 1:
TrueCon1 cable		CAL 1,2,3 : TEST 1,2,3,4: SOF 1, 2:
Microfiber cloth		REP 4 : CLE 1,2,4,5 :

Neutral pH glass cleaner (alcohol and ammonia-free).		REP 4 : CLE 1,2 :
Cotton swab		CLE 2,3,45 :
Isopropyl alcohol		CLE 2,3,4 :
Dish soap		CLE 5:
All-purpose cleaner		CLE 5:

Fixture menu and connectors.

Menu buttons

A rotative knob allows you to navigate in the menu and selects by clicking.

Display

The LCD Display shows fixture and menu information.

Indicator LEDs

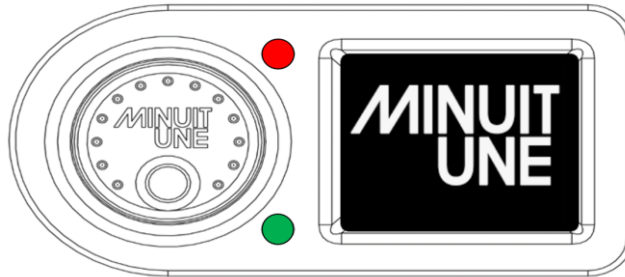

safety indicator (red, left from display)	Lights up when the scanning speed reach 330Hz.
DMX interlock indicator (green, right from display)	Lights up green when a valid DMX signal is detected at the DMX input.

DMX connectors

The product is equipped with 5-pin XLR sockets DMX input and output (through to next fixture).

The pin-out of the XLR connectors is:

- pin 1 = shield
- pin 2 = cold (-)
- pin 3 = hot (+).

Pins 4 and 5 in the 5-pin XLR connectors are not used in the fixture but are available for possible additional data signals as required by the DMX512-A standard. Standard pin-out is pin 4 = data 2 cold (-) and pin 5 = data 2 hot (+).

Power Connectors

The product is equipped with two Neutrik Powercon TRUE1 connectors for power in power-in. and power-through. Use only Neutrik Powercon TRUE1 NAC3FX-W-TOP cable connectors to connect to power input sockets. Use only Neutrik Powercon TRUE1 NAC3MX-W-TOP cable connectors to connect to power throughout sockets.

Adjustable mounting yoke

The product is shipped with an adjustable mounting yoke to which rigging clamps can be attached.

Screen : IVL dice Menu		Tools/Equipment: TrueCon1 cable
		CAUTION! Class 3R laser procedure. Avoid direct eye exposure.
	Description	Image
Screen 1	Standby screen On this standby screen it can be observed: <ul style="list-style-type: none"> •The DMX mode (mode 1) •The DMX address (address 1) •The laser temperature (which is fix to 25°). 	
Screen 2	Main menu Press the knob to reach the main menu.	
Screen 3	DMX mode Two modes are available(dmx protocol chapter at the end of this manual for more detailed information): <ul style="list-style-type: none"> • DMX 1. which has 1 color and dimmer by tilt mirror. • DMX 2. which has 2 color and dimmer by tilt mirror. 	

<p>Screen 4</p>	<p>DMX address To update DMX address of the product: Select digit by turning the knob and click on it to pass to the next digit.</p>	
<p>Screen 5</p>	<p>Service menu Clicking on maintenance in the main menu will open the maintenance/service menu:</p>	
<p>Screen 6</p>	<p>Calibration In calibration procedures to re-calibrate the product will appear:</p>	
<p>Screen 7</p>	<p>Autorun Pre-set effect/function to test the product can be finded:</p>	

<p>Screen 8</p>	<p>DMX viewer All the real-time dmx data received by the product is displayed:</p>	
<p>Screen 9</p>	<p>Temperature In temperatures menu the temperature if the laser and the mother board can be tracked. On the left in white the, live temperature. On the right in yellow, the maximal recorded temparture for this module</p>	
<p>Screen 10</p>	<p>Lifetime The life time of the different modules Istracked in hours of use. C.motor is recording the lifetime of the scanning system (recorded on the mother board). Laser, red, green and blue is recording the life time of each RGB diode of the laser module.</p>	
<p>Screen 11</p>	<p>About The following information is displayed: •Software version. •Maximal laser temperature recorded. •Lifetime of the product. Clicking once again to display the module's software versions.</p>	
<p>Screen 12</p>	<p>Flip screen To revert the displaying of the screen menu. Reset menu To do a manual reset of the product.</p>	

MAINTENANCE

This product does not require any regular scheduled maintenance to keep the product in compliance.

TROUBLESHOOTING

In this section we will go over the potential issues you could observe on an operational product.

Never attempt to repair this product if you don't see your problem in this troubleshooting and contact us for assistance.

Never attempt to repair the product by yourself if the solution says a laser operation is needed and contact us for assistance.

If you don't succeed to repair the product following this troubleshooting, or if you have any doubt concerning the different procedure, contact us for assistance.

To continuously improve our customer service and our product, if you manage to repair the product following this troubleshooting, we also invite you to communicate us the reference of the issue you have encountered.



Minuit une Service
service@minuitune.com
<https://minuitune.com>

When contacting our customer service, please fill the Service Return Form which is available in annex of this service manual or in the download section of the Minuit Une website and attach photo and/or video to explain the problem.

PRODUCT IS NOT EMITING LIGHT OUTPUT

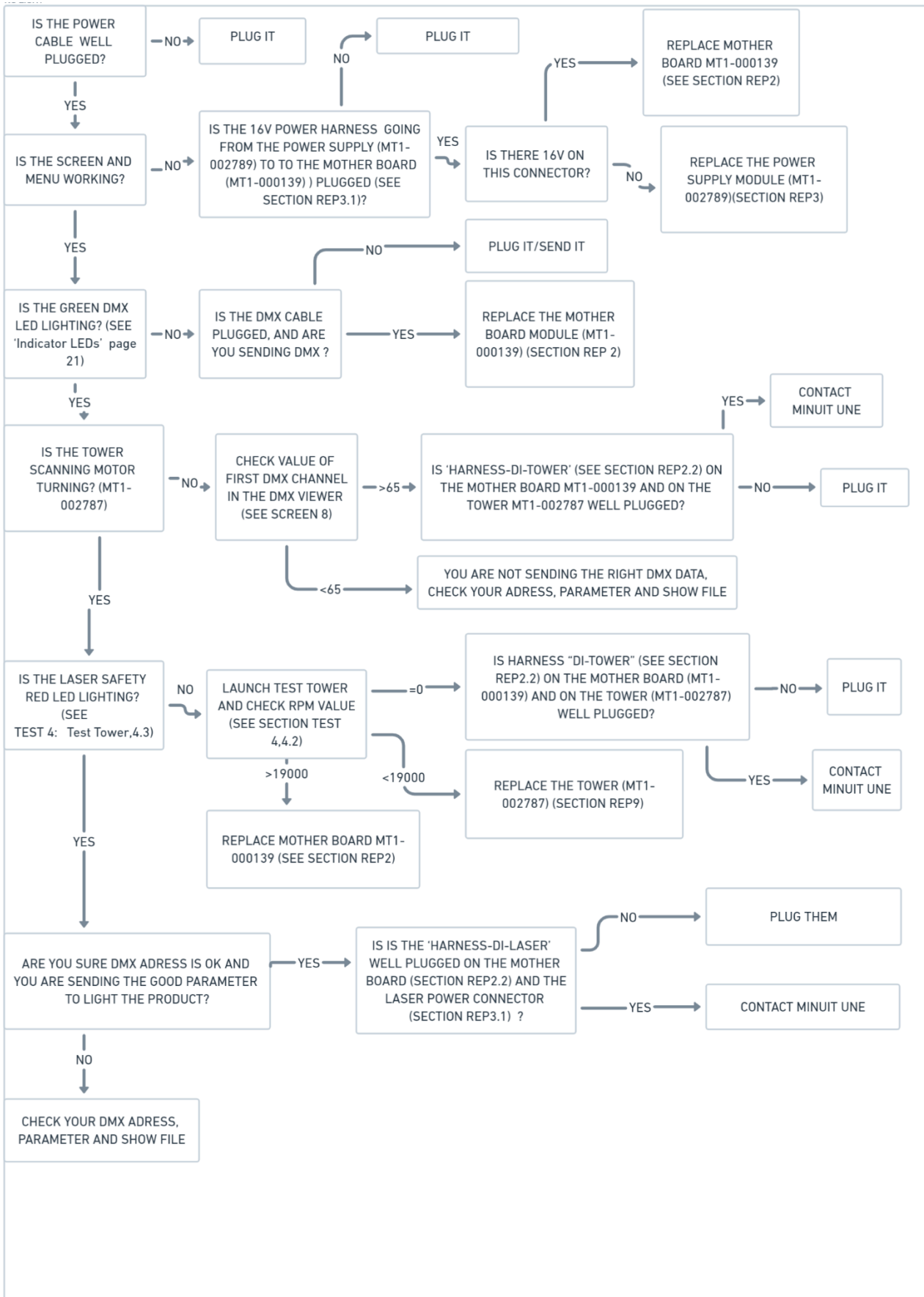

PRODUCT IS EMITTING UNUSUAL/ABNORMAL LIGHT

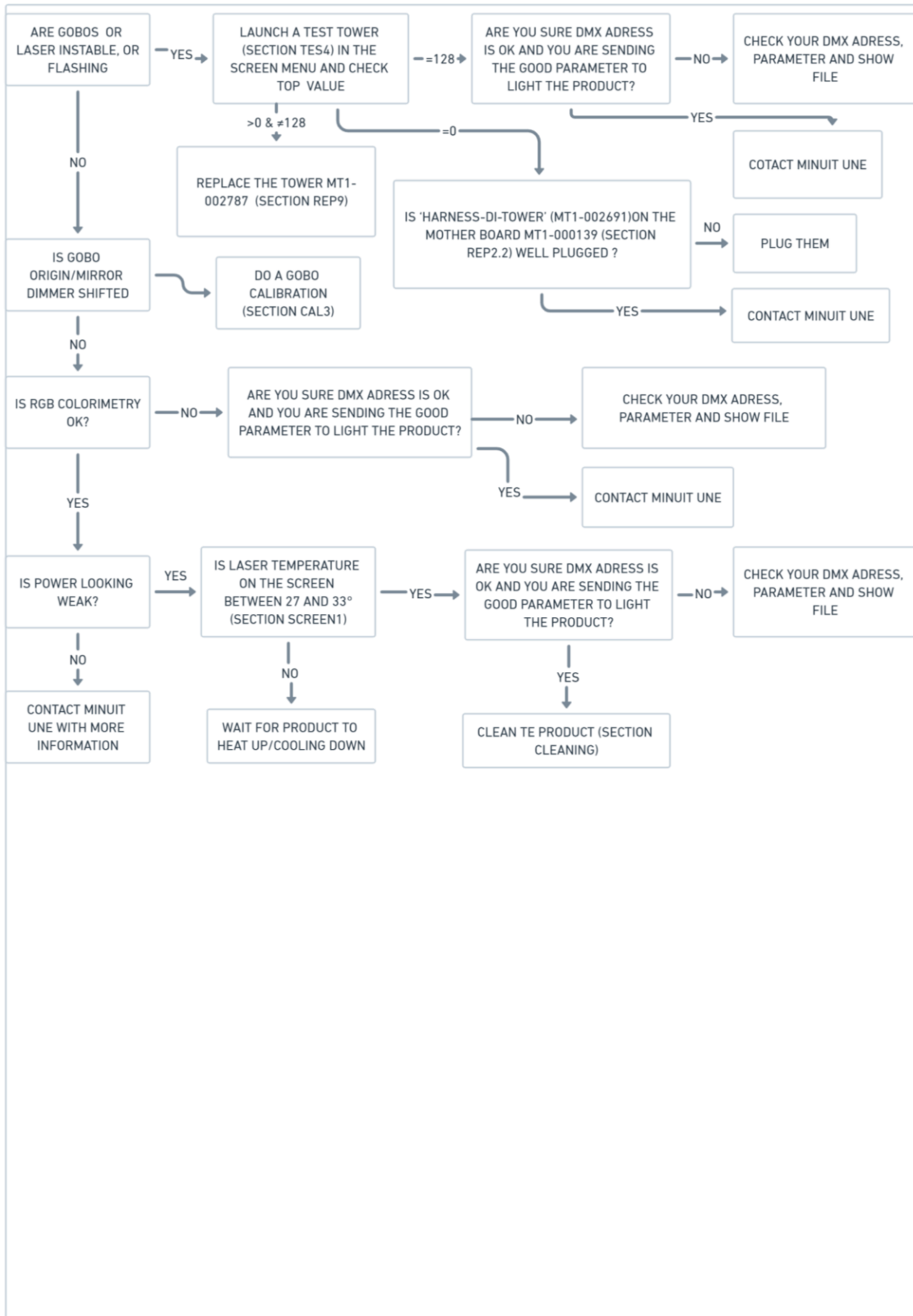

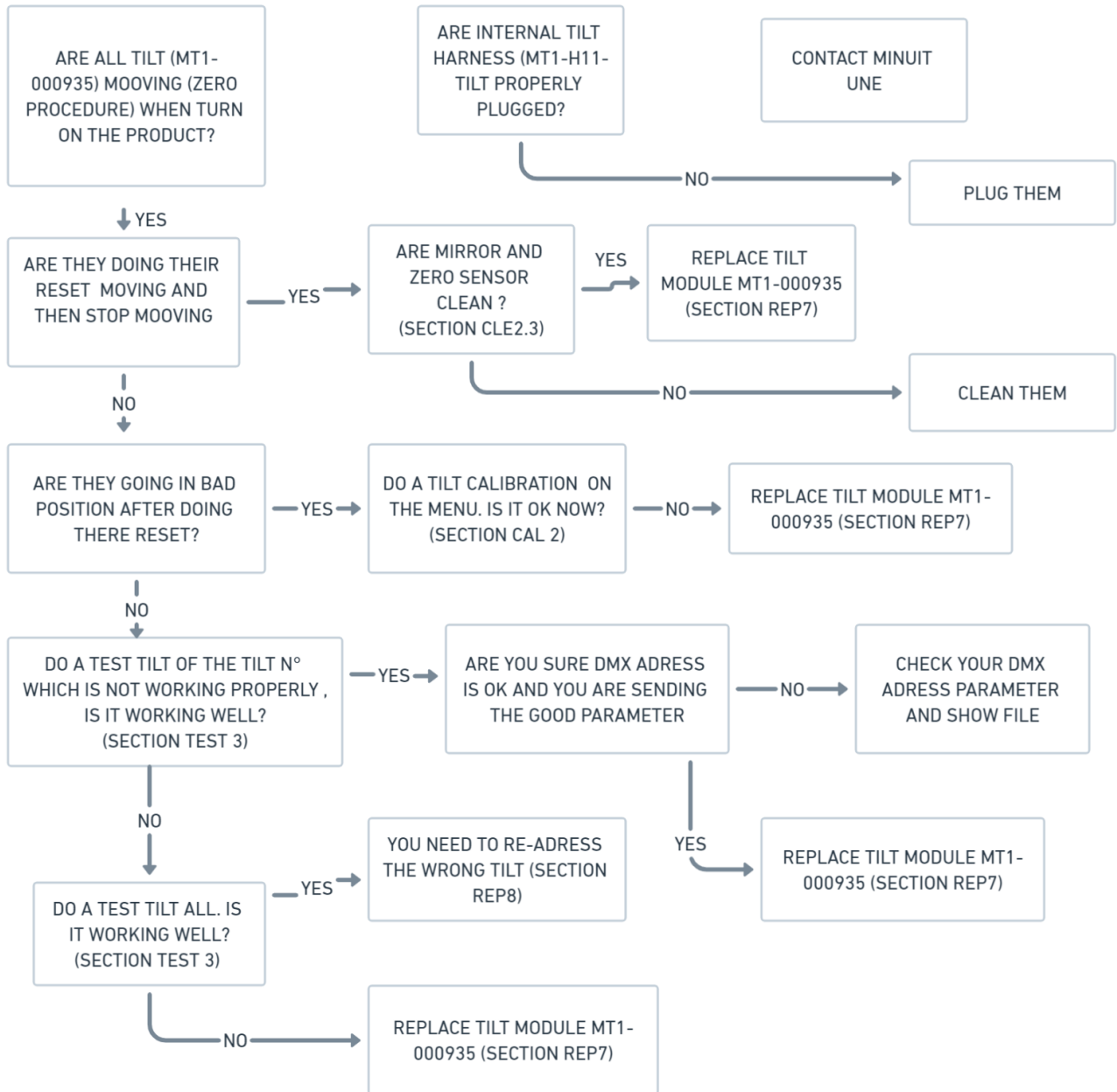

TILT PROBLEM



SERVICE OPERATION

REPLACING SPARE PARTS OPERATION

Unless explicitly stated by Minuit Une, do not dismantle the modules, as **this will invalidate the warranty.**

<p>REP 1: REPLACING DICE-BOTTOM-HOUSING-AND- INSERTS (MT1-002461)</p>	<p>Tools/Equipment :</p>	<p>TORX T30 SCREWDRIVER</p>
	<div style="background-color: yellow; padding: 10px; border: 1px solid black;"> <div style="display: flex; justify-content: space-between; align-items: center;">  <div style="text-align: center;"> <p>DANGER</p> <p><i>ALWAYS TURN OFF AND DISCONNECT THE PRODUCT BEFORE OPENING THE PRODUCT OR PERFORMING THIS DESCRIBED SERVICE PROCEDURE. DANGEROUS CLASS 4 LASER RADIATION POTENTIALLY ACCESSIBLE IF THESE INSTRUCTIONS ARE NOT FOLLOWED WHICH COULD RESULT IN SEVERE EYE OR SKIN INJURY.</i></p> </div>  </div> </div>	

	<p>Instructions</p>	<p>Diagram</p>
--	---------------------	----------------

1.1

Unscrew the 4 QUARTER-TURN-TORX-T30-SCREW-3 (MT1-002696) like shown on the photo by a quarter turn.

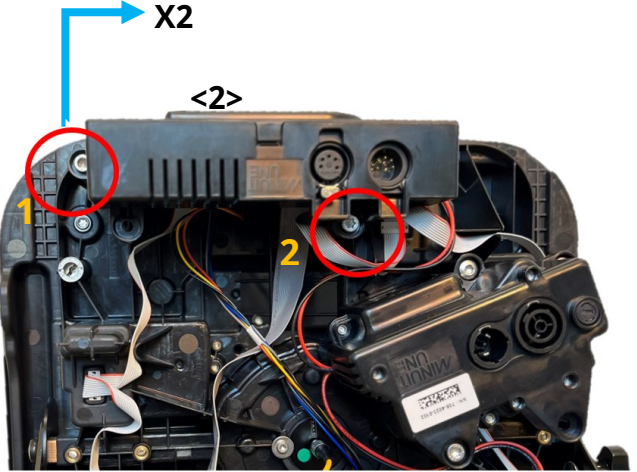

<p>1.2</p>	<p>Lift the back panel DICE-BOTTOM-HOUSING-AND-INSERTS (MT1-002461) and remove it.</p> <p>Rotate the DICE-YOKE (MT1-002354) (A) to remove the MT1-002461 if necessary.</p> <p>When putting it back in place, make sure the cables are well positioned and not get stuck under the cover.</p>	
-------------------	---	--

<p>REP 2: REPLACING MOTHER-PCB-ASSEMBLY (MT1-000139)</p>	<p>Tools/Equipment:</p>	<p>TORX T30 screwdriver</p>
<p>Instructions</p>	<p>Diagram</p>	
<p>2.1</p>	<p><1> Remove the DICE-BOTTOM-HOUSING-AND-INSERTS(MT1-002461) (REP 1:).</p> <p><2>Then, unscrew the 2 SCREW-M6-40-TORX (MT1-002508) using a TORX T30 screwdriver.</p>	

<1> Gently unplug all the connectors from the MOTHER-PCB-ASSEMBLY(MT1-000139)

2.2 <2> When plugging them back, be careful with their direction and coded pin following the opposite diagram.

<1>



Back view

<2>

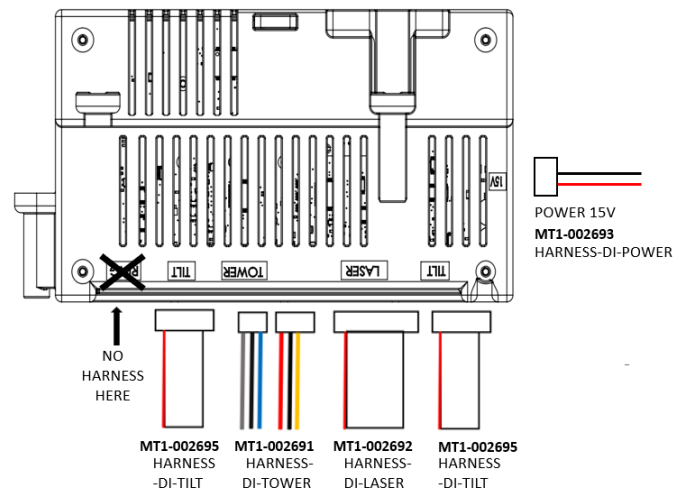



<1> When fixing the MT1-000139 back in its place, make sure that it is resting on its fixation point and centering pin (A) and that no cables are squeezed underneath.

2.3 Tight the screws with a torque of 2 Nm.

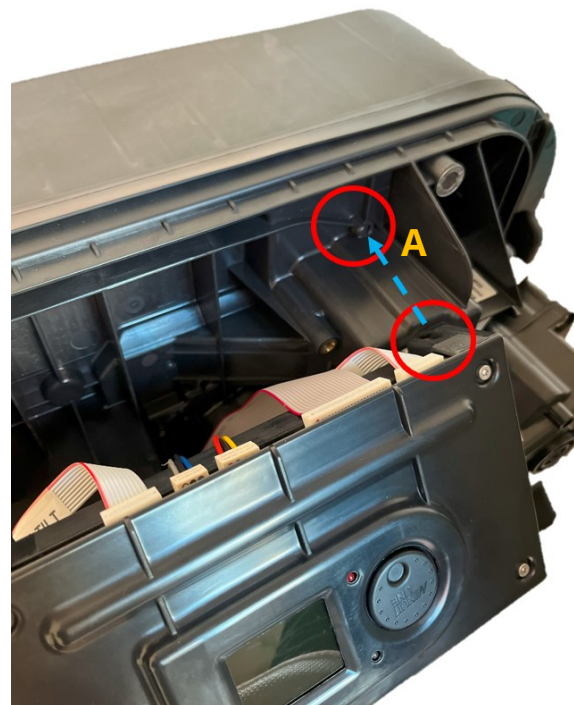
After finishing the assembly , a full SW update(See section SOF 1:, SOF 2:) and: E-gobo calibration(see section CAL3:) must be performed.



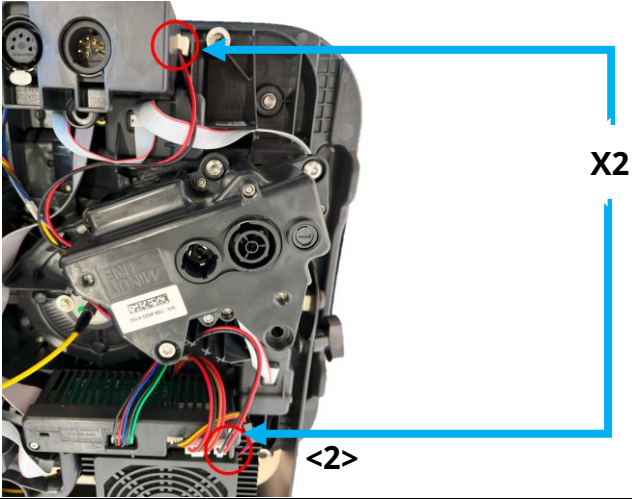
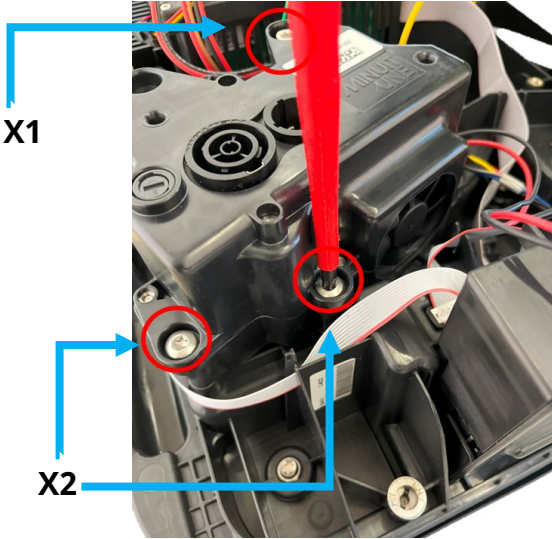

<p>REP 3: REPLACING DICE-POWER-SUPPLY-ASSEMBLY (MT1-002789)</p>	<p>Tools/Equipment</p>	<p>TORX T30 screwdriver</p>
<div style="background-color: yellow; padding: 10px; border: 1px solid black;"> <div style="display: flex; justify-content: space-between; align-items: center;">  <div style="text-align: center;"> <p>DANGER</p> <p><i>ALWAYS TURN OFF AND DISCONNECT THE PRODUCT BEFORE OPENING THE PRODUCT OR PERFORMING THIS DESCRIBED SERVICE PROCEDURE. DANGEROUS CLASS 4 LASER RADIATION POTENTIALLY ACCESSIBLE IF THESE INSTRUCTIONS ARE NOT FOLLOWED WHICH COULD RESULT IN SEVERE EYE OR SKIN INJURY.</i></p> </div>  </div> </div>		
	<p>Instructions</p>	<p>Diagram</p>
<p>3.1</p>	<p><1> Remove the DICE-BOTTOM-HOUSING-AND-INSERTS(MT1-002461) (REP 1:).</p> <p><2> Gently unplug the 2 connectors from the DICE-POWER-SUPPLY-ASSEMBLY (MT1-002789). Be careful with their direction.</p>	
<p>3.2</p>	<p><1> Unscrew the SCREW-M6-20-TORX (MT1-002288) like shown in the diagram.</p> <p><2> Unscrew the 2 SCREW-M6-35-TORX (MT1-003029) like shown in the diagram.</p>	

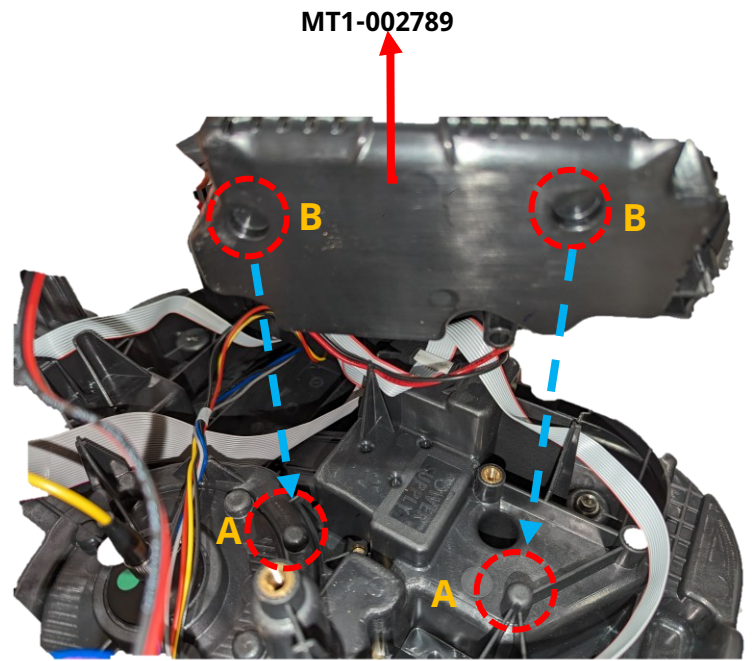

<3> When fixing the **MT1-002789** back in its place, make sure that it is resting on its fixation points and centering pins (**A&B**) and that the 2 connectors are plugged.

Tight the screws with a torque of 2 Nm.

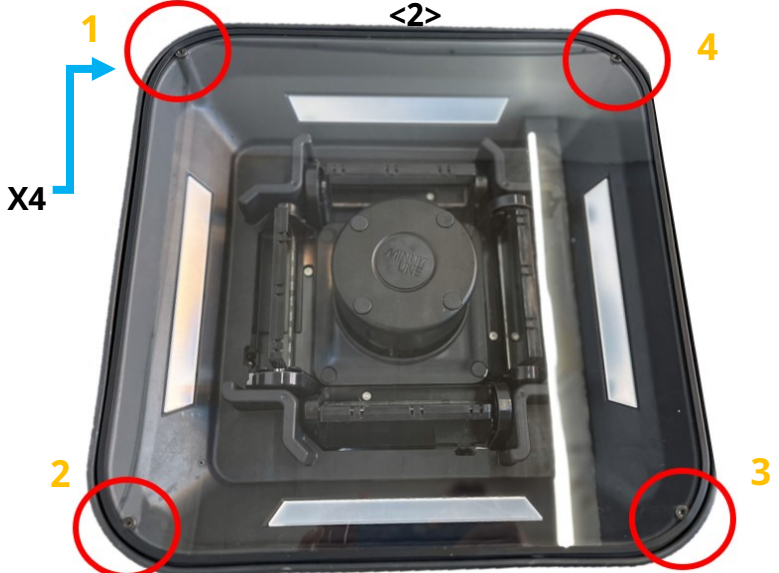
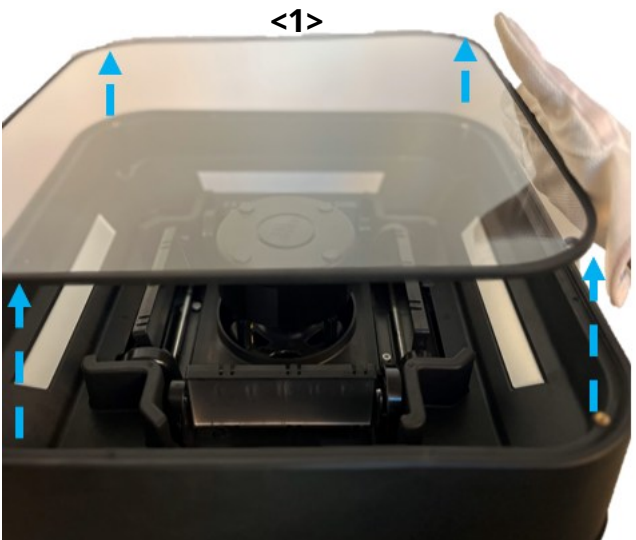

<p>REP 4: REPLACING DICE-TRANSPARENT-COVER (MT1-001645)</p>	<p>Tools/Equipment</p> <ul style="list-style-type: none"> - TORX T20 screwdriver - A microfiber cloth - A non-alcoholic glass cleaner 	
<div style="background-color: yellow; padding: 10px; border: 1px solid black;"> <div style="display: flex; justify-content: space-between; align-items: center;">  <div style="text-align: center;"> <p>DANGER</p> <p><i>ALWAYS TURN OFF AND DISCONNECT THE PRODUCT BEFORE OPENING THE PRODUCT OR PERFORMING THIS DESCRIBED SERVICE PROCEDURE. DANGEROUS CLASS 4 LASER RADIATION POTENTIALLY ACCESSIBLE IF THESE INSTRUCTIONS ARE NOT FOLLOWED WHICH COULD RESULT IN SEVERE EYE OR SKIN INJURY.</i></p> </div>  </div> </div>		
	<p>Instructions</p>	<p>Diagram</p>
<p>4.1</p>	<p><1> Remove the DICE-BOTTOM-HOUSING-AND-INSERTS(MT1-002461) (REP 1:).</p> <p><2> Unscrew the 4 SCREW-M4-8-FLAT-HEAD-TORX (MT1-003041) .</p>	
<p>4.2</p>	<p><1> Gently lift the DICE TRANSPARENT-COVER(MT1-001645) and put it aside on a soft surface.</p> <p>Before putting the transparent cover back in its position, make sure the tilt mirrors MT1-000935 and the transparent cover are clean, with no fingerprints or dust on them. Clean with microfiber cloth and a non-alcoholic glass cleaner if needed.</p>	

<p>4.3</p>	<p>Position back the MT1-001645 with its DICE-GLOBE-SEAL(MT-002314) (A) onto the assembly.</p> <p>a. <u>Make sure to align the joints of the MT1-002639 and the MT-002314 (A).</u></p> <p>b. <u>Pay attention to the assembly direction; the drilled holes are positioned facing upwards.</u></p>	
<p>4.4</p>	<p><1> Screw the 4 SCREW-M4-8-FLAT-HEAD-TORXK (MT1-003041) back.</p> <p><i>Tight the screws with a torque of 0,6 Nm. <u>Pay attention this piece is sensitive to strong torque.</u></i></p> <p><2> While screwing, lightly lift the SEAL (MT-002314) surrounding the MT1-001645 with your finger to place it over the screw head.</p>	

<p>REP 5: REPLACING MASK-MIRROR-AND-FROST-ASSEMBLY (MT1-002639)</p>	<p>Tools/Equipment</p>	<p>TORX T30 screwdriver</p>
	<div style="background-color: yellow; padding: 10px; border: 1px solid black;">  <p style="text-align: center;">DANGER</p> <p style="text-align: center; font-size: small;">ALWAYS TURN OFF AND DISCONNECT THE PRODUCT BEFORE OPENING THE PRODUCT OR PERFORMING THIS DESCRIBED SERVICE PROCEDURE. DANGEROUS CLASS 4 LASER RADIATION POTENTIALLY ACCESSIBLE IF THESE INSTRUCTIONS ARE NOT FOLLOWED WHICH COULD RESULT IN SEVERE EYE OR SKIN INJURY.</p>  </div>	

<p>Instructions</p>	<p>Diagram</p>
---------------------	----------------

5.1

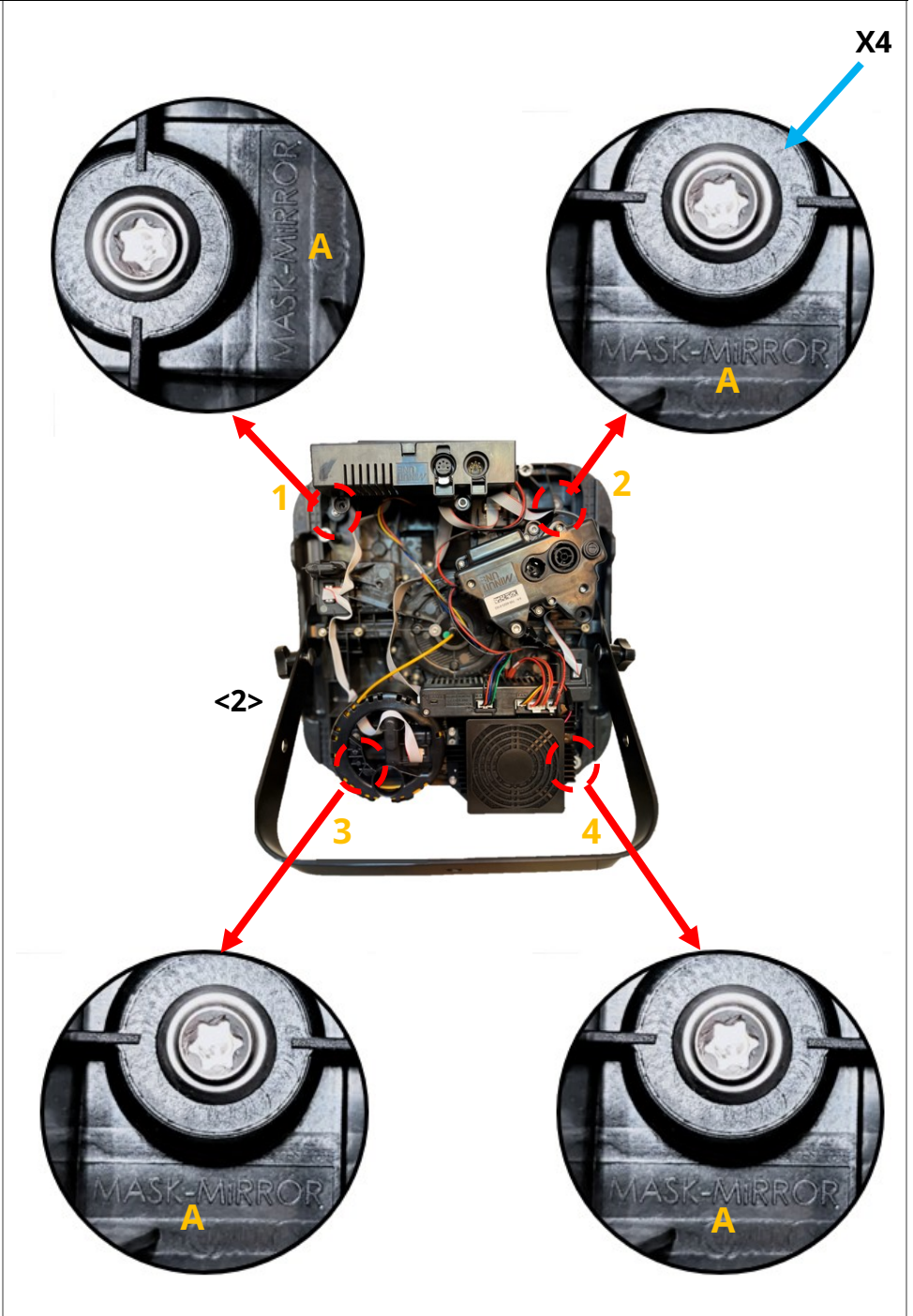

<1> First, remove the DICE-BOTTOM-HOUSING-AND-INSERTS(MT1-002461) (**REP 1:**).

<2> On the back surface, unscrew in the 4 quarter-turn MT1-002696 screws embedded in the housing MT1-001659, where 'MASK-MIRROR' (**A**) is engraved.

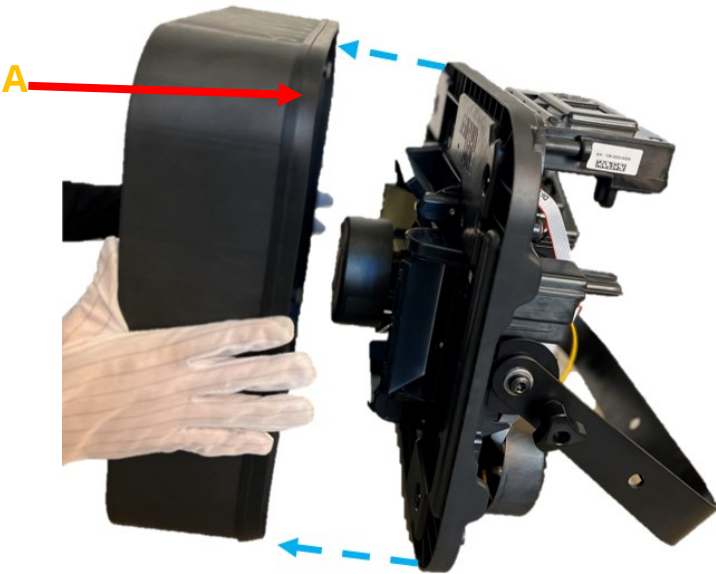
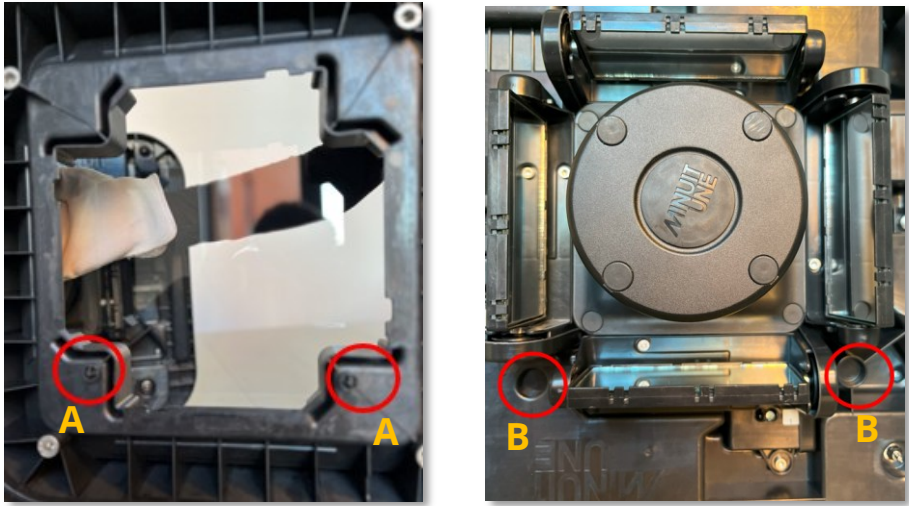

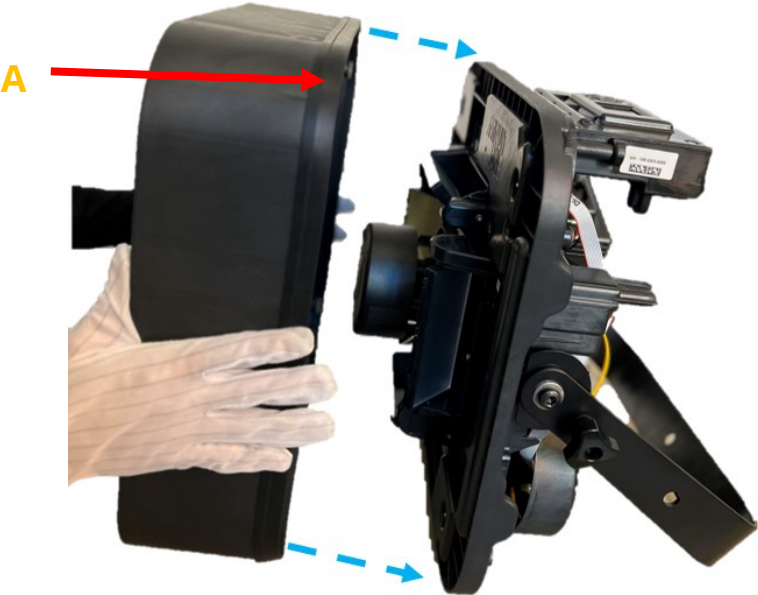
<p>5.2</p>	<p>Lift the MASK-MIRROR-AND-FROST-ASSEMBLY (MT1-002639).</p> <p>Put attention to the DICE-HOUSING-SEAL(MT1-002360) (A) that surrounds the MT1-002639.</p>	
<p>5.3</p>	<p>To put the MT1-002639 back, <u>pay attention to the fixation points and centering pins (A&B) indicating the assembly direction.</u></p>	

<p>Carefully assemble the MT1-002639 firmly.</p> <p>When putting back the MT1-002639 be careful not to crush the DICE-HOUSING-SEAL (MT1-002360) (A) and ensure that the 4 quarter-turn MT1-002696 screws are properly tightened against the piece MT1-002639 .</p> <p>5.4</p> <p><i>Caution when screwing the MT1-002639 back; it may give the impression of being held by the quarter-turn MT1-002696 screws . If the MT1-002639 is not secured by the screws, it can cause a flatness issue.</i></p>	
---	--

REP 6: REPLACING DICE-INTERNAL-TOP-COVER (MT1-002325)	Tools/Equipment -TORX T15 screwdriver -2.5 mm Flat head screwdriver
	<p>DANGER ALWAYS TURN OFF AND DISCONNECT THE PRODUCT BEFORE OPENING THE PRODUCT OR PERFORMING THIS DESCRIBED SERVICE PROCEDURE. DANGEROUS CLASS 4 LASER RADIATION POTENTIALLY ACCESSIBLE IF THESE INSTRUCTIONS ARE NOT FOLLOWED WHICH COULD RESULT IN SEVERE EYE OR SKIN INJURY.</p>  

Instructions	Diagram
--------------	---------

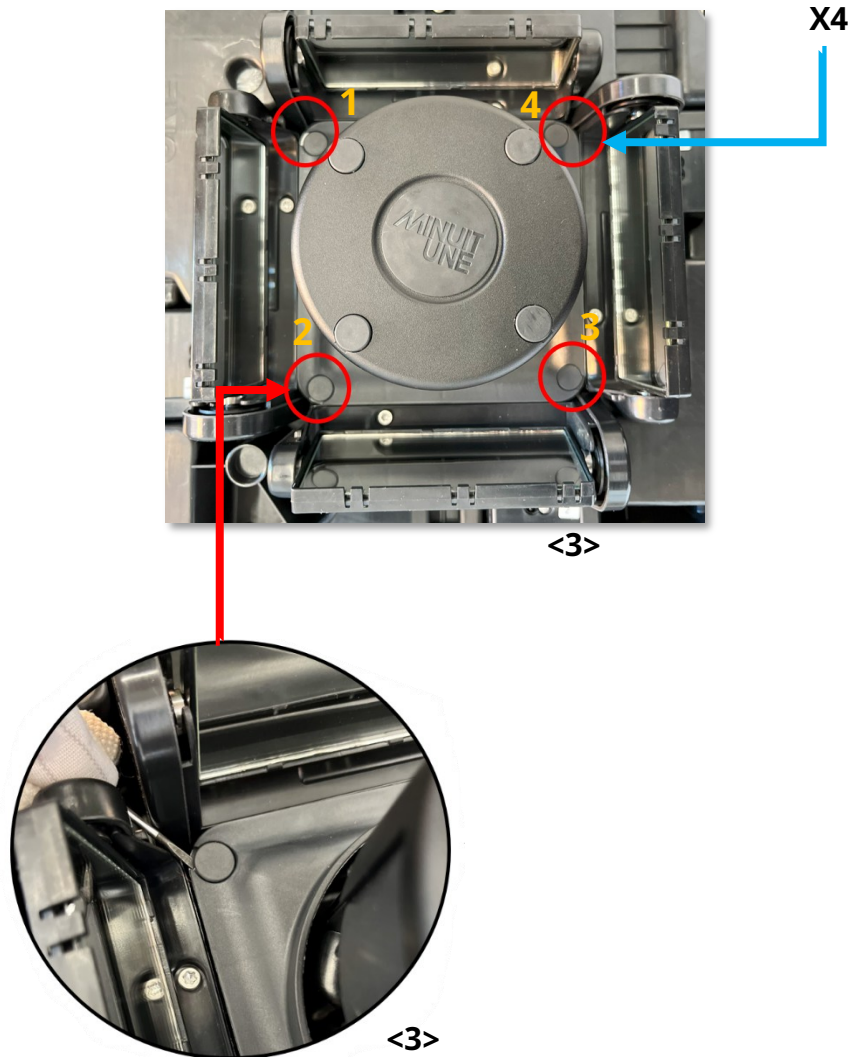
<p>6.1</p> <p><1> Remove the DICE-BOTTOM-HOUSING-AND-INSERTS(MT1-002461) (REP 1:).</p> <p><2> Remove the MASK-MIRROR-AND-FROST-ASSEMBLY (MT1-002639) (REP 5:).</p> <p><3> With the help of a flat head screwdriver unclip the 4 SCREW-MASK (MT1-001600) on the MT1-002325.</p>	 <p style="text-align: right;">X4</p> <p style="text-align: center;"><3></p> <p style="text-align: center;"><3></p>
--	---

6.2

Unscrew the 4 SCREW-M3-20-TORX (MT1-000656).

6.3

Lift the **DICE-INTERNAL-TOP-COVER(MT1-002325)** and put attention to the seal.

6.4

<1> To put the **MT1-002325** back, pay attention to the centering pins (**A** and **B**, **A** one large cylinder and **B** one small) indicating the assembly direction.

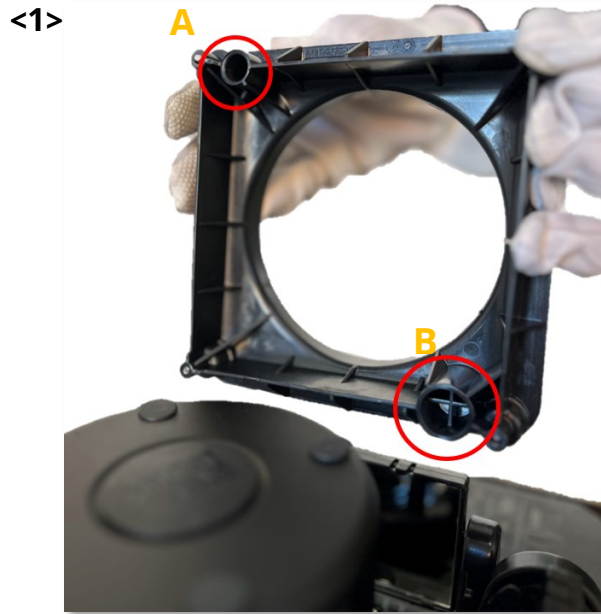

<2> The centering pins are also found in the main housing (MT1-001659). Make sure that MT1-002325 is resting on its fixation point and centering pins (**A** and **B**).

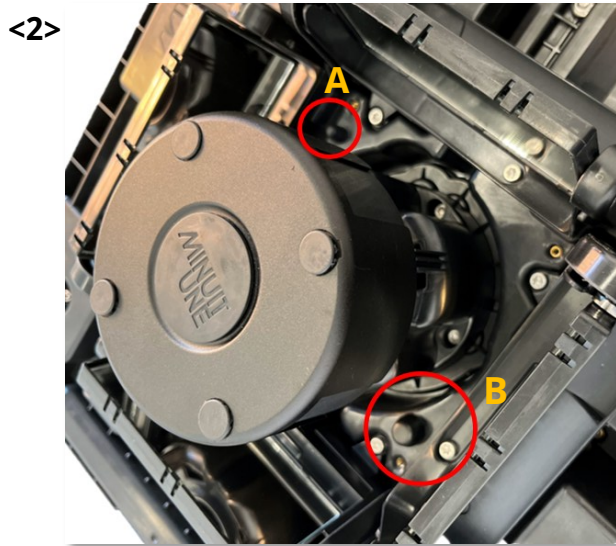

<1>, X4

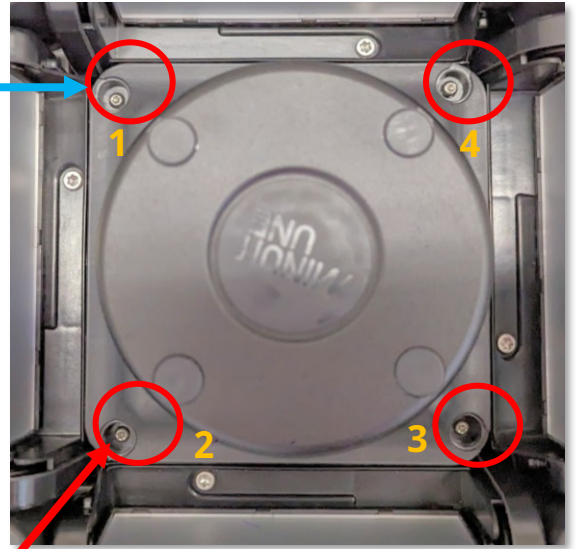



<1> Screw the 4 SCREW-M3-20-TORX (MT1-000656) back.

Tight the screws with a torque of 0,6 Nm.

<2> Clip the 4 SCREW-MASK (MT1-001600) into the grooves of the MT1-002325.

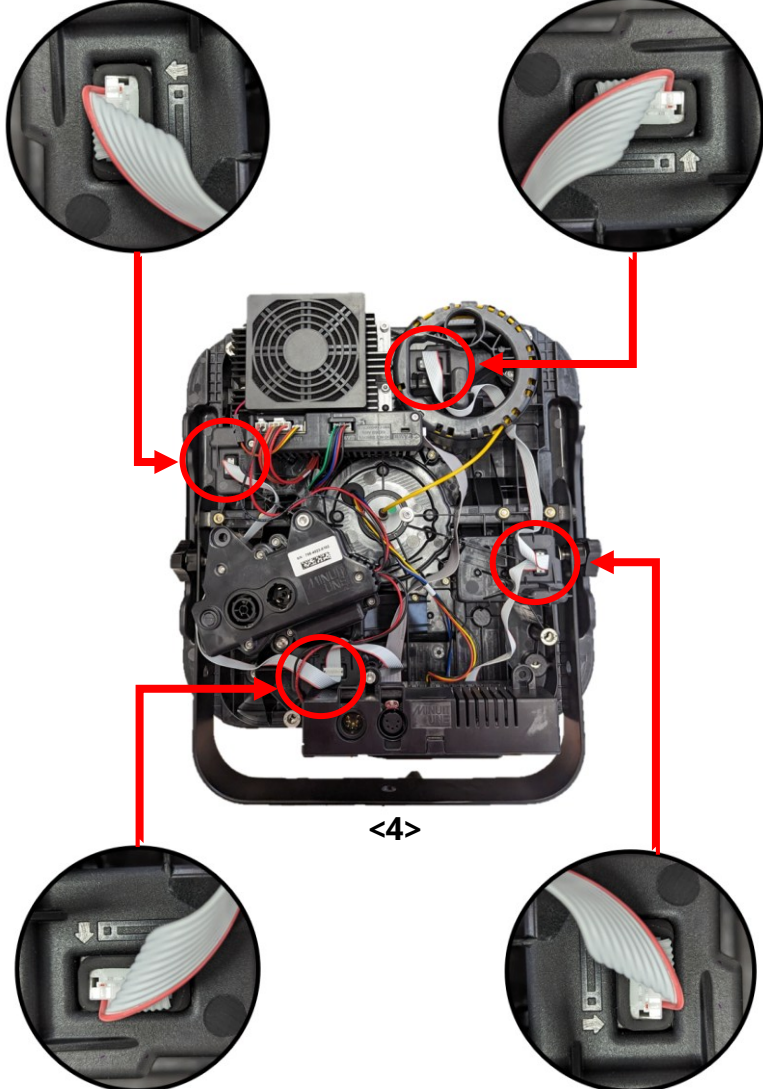
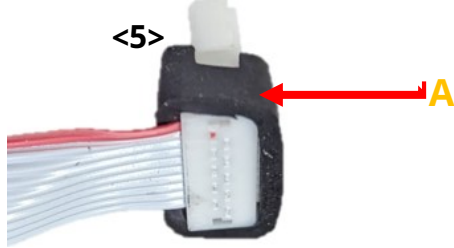

6.5

<p>REP 7: REPLACING LATERAL-BELT-ACTUATOR-ASSEMBLY (MT1-000935)</p>	<p>Tools/Equipment</p>	<p>TORX T20 screwdriver</p>
	<div style="background-color: yellow; padding: 10px; border: 1px solid black;"> <div style="display: flex; justify-content: space-between; align-items: center;">  <div style="text-align: center;"> <p>DANGER</p> <p><i>ALWAYS TURN OFF AND DISCONNECT THE PRODUCT BEFORE OPENING THE PRODUCT OR PERFORMING THIS DESCRIBED SERVICE PROCEDURE. DANGEROUS CLASS 4 LASER RADIATION POTENTIALLY ACCESSIBLE IF THESE INSTRUCTIONS ARE NOT FOLLOWED WHICH COULD RESULT IN SEVERE EYE OR SKIN INJURY.</i></p> </div>  </div> </div>	
	<p>Instructions</p>	<p>Diagram</p>
<p>7.1</p> <p><1> Remove the DICE-BOTTOM-HOUSING-AND-INSERTS(MT1-002461) (REP 1:).</p> <p><2> Remove the MASK-MIRROR-AND-INSERTS-FROST-ASSEMBLY (MT1-002639) (REP 5:)</p> <p><3> Remove DICE-INTERNAL-TOP-COVER(MT1-002325) (REP 6:).</p> <p><4> Gently unplug the HARNESS-DI-TILT(MT1-002695) of the Tilt module from the back of the fixture, like shown in the diagram.</p> <p><5> Make sure not to lose the CONNECTOR-SEAL(MT1-001037) (A) of the connector when unplugging it.</p>	 <p style="text-align: center;"><4></p>  <p style="text-align: center;"><5></p>	

7.2

<1> Unscrew the 3 SCREW-M4-8-TORX(MT1-001699) using a TORX T20 screwdriver.

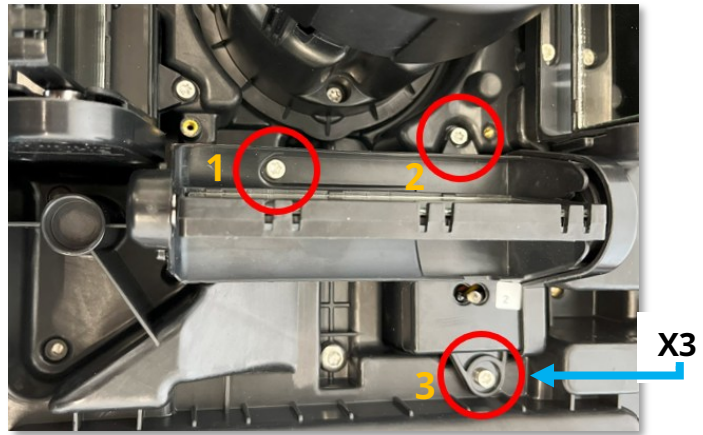

<2> Lift the MT1-000935.



7.3

<1> Make sure that the MAIN-HOUSING-LATERAL-SEAL(MT1-001057) (A) which is shown in the image stays in its place on the fixture's body, under the MT1-000935.

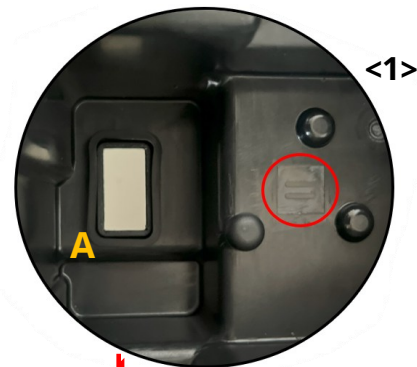

<2> Before putting back the MT1-000935, you need to check the TILT address (REP8:).

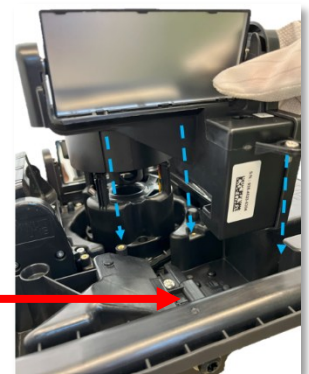

7.4

<1> With the help of the **centering pins (A)** found on MT1-001057 and in the MT1-000935 , position the MT1-000935 back.

<2> When fixing back the MT1-000935 in its place, make sure that MAIN-HOUSING-LATERAL-SEAL(MT1-001057) is in its place and the MT1-000935 is well positioned on its **resting points and centering pin.**

Tight the screws with a torque of 1.2 Nm.

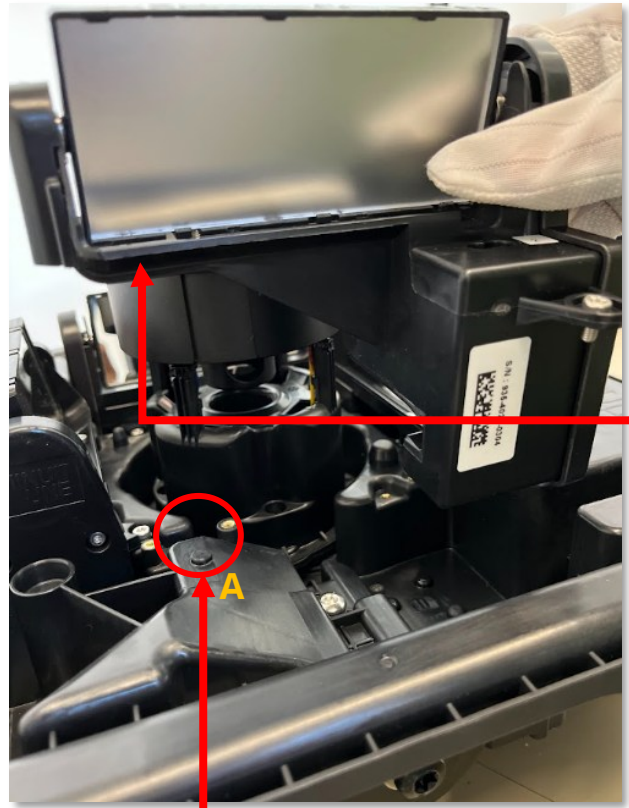

<1>

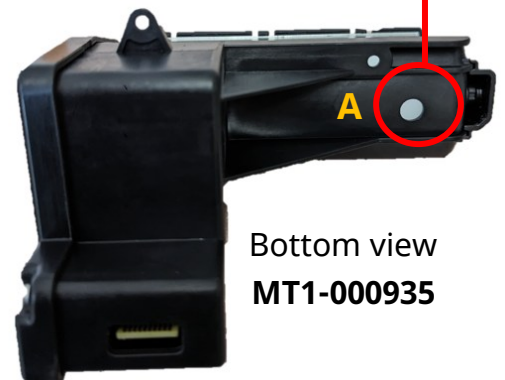

Bottom view
MT1-000935

7.5

<1> Plug back the connector MT1-002695, be careful of the direction (A) and of the seal (B) MT1-001037.

<2> An arrow (C) is here to indicate you the direction (A) of the connector (arrow=red wire).

<3> After assembling the fixture back, you must do a full SW update (See section **SOFT 1:** and **SOFT 2:**) and a tilt calibration (see section **CAL 2:**).

<1>

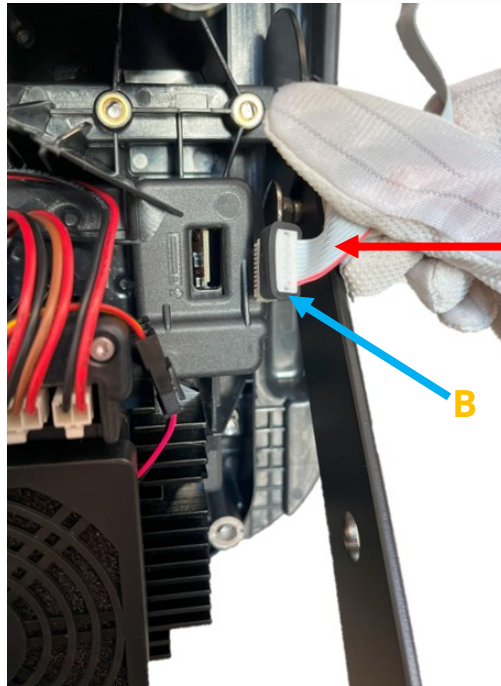

<2>

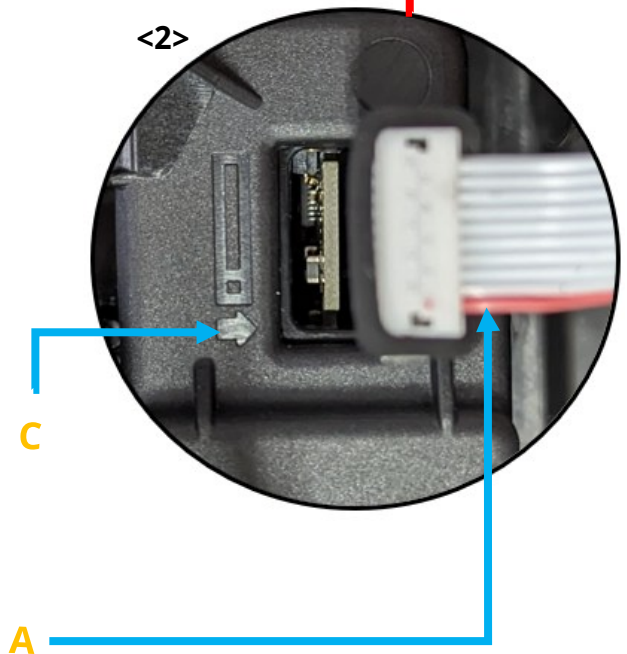

REP 8: ADRESSING LATERAL-BELT-ACTUATOR-ASSEMBLY (MT1-000935)	Tools/Equipment	TORX T10 screwdriver
	Instructions	Diagram

8.1

To change a tilt module **MT1-000935**, the new module must be addressed correctly.

For example, if **MT1-000935 #2** is being replaced, the new **MT1-000935** should be addressed accordingly (step **8.2** in this same procedure).

<1> Identify the number of the **MT1-000935** to replace.

The identification number of the tilt **MT1-000935** can be found:

- A.** Engraved on the MASK-MIRROR-AND-FROST-ASSEMBLY (MT1-002629).
- B.** On a white label on the **MT1-000935**.
- C.** Engraved on the DICE-MAIN-HOUSING-AND-INSERTS (MT1-001659) when a **MT1-000935** is removed.

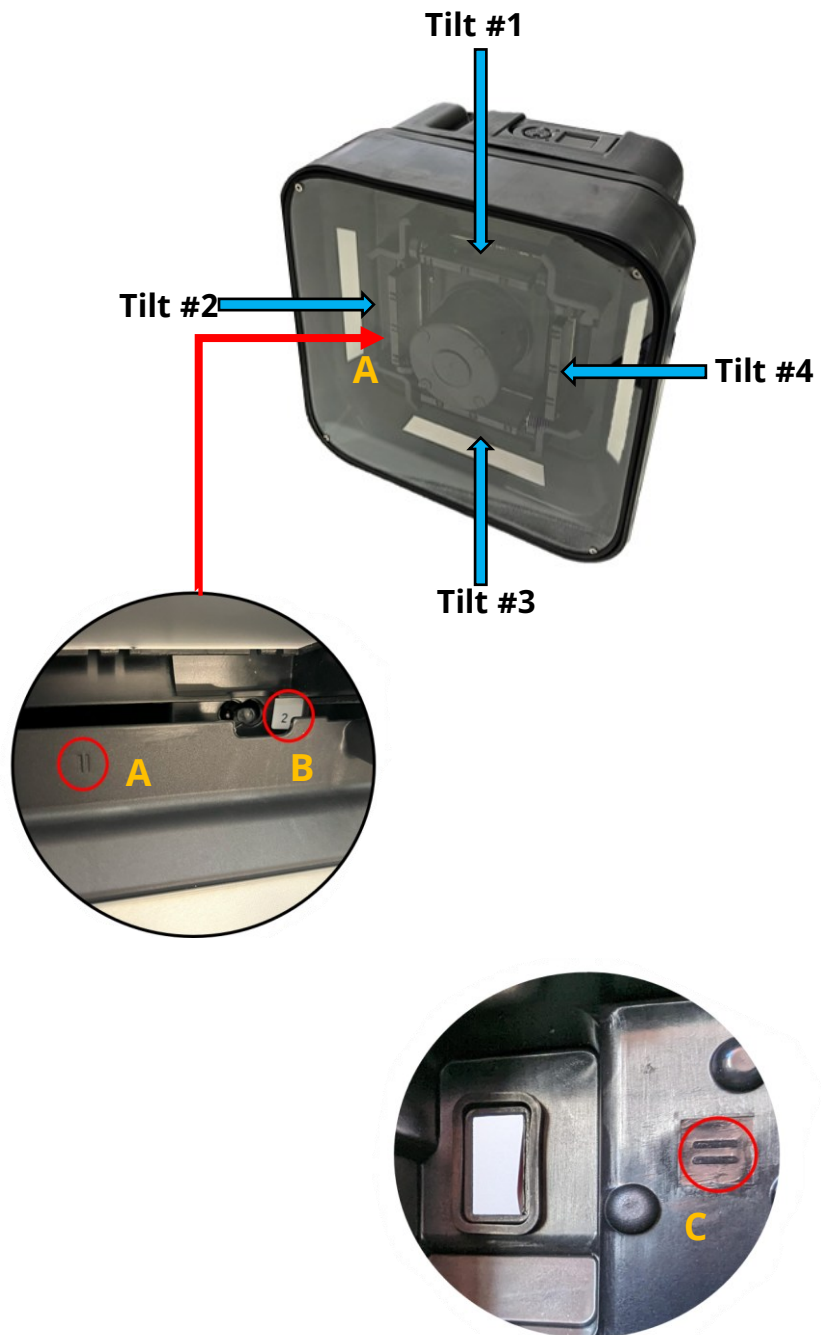

8.2

<1> On the **MT1-000935**, identify a slot where a DIP-SWITCH can be observed , which will be used for the addressing procedure.

<2> In some **MT1-000935** versions, the slot for addressing is not present. In that case, it is necessary to open the **MT1-000935** and remove the PCB to assign address.

<3> Use the binary code to address **MT1-000935** according to the number module to be replaced.

(Switch towards the bottom = 1)

- A. 000 = **MT1-000935** #1
- B. 001 = **MT1-000935** #2
- C. 010 = **MT1-000935** #3
- D. 011 = **MT1-000935** #4

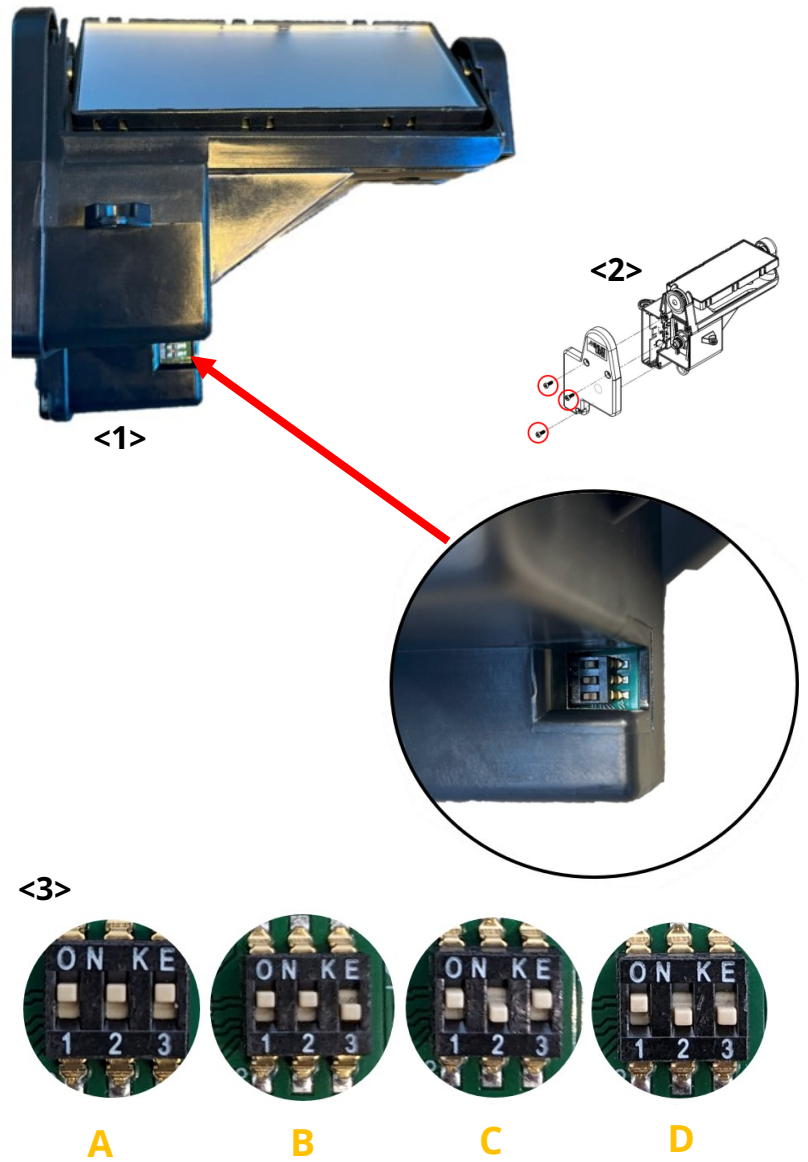

8.3

Once the **MT1-000935** has been replaced, a full SW update (See section **SOF 1: and SOF 2:**) and a tilt calibration (see section **CAL2:**) need to be performed to ensure that the new module and the fixture have the same software version and all the **MT1-000935** have the same position origin.

REP 9: REPLACING DICE-CENTRAL-TOWER-ASSEMBLY (MT1-002787)	Tools/Equipment	TORX T20 screwdriver
	<div style="background-color: yellow; padding: 10px; border: 1px solid black;"> <div style="display: flex; justify-content: space-between; align-items: center;"> <div style="text-align: center;"> <p>DANGER</p> <p><i>ALWAYS TURN OFF AND DISCONNECT THE PRODUCT BEFORE OPENING THE PRODUCT OR PERFORMING THIS DESCRIBED SERVICE PROCEDURE. DANGEROUS CLASS 4 LASER RADIATION POTENTIALLY ACCESSIBLE IF THESE INSTRUCTIONS ARE NOT FOLLOWED WHICH COULD RESULT IN SEVERE EYE OR SKIN INJURY.</i></p> </div> </div> </div>	

Instructions	Diagram
---------------------	----------------

9.1

<1> Remove the DICE-BOTTOM-HOUSING-AND-INSERTS (MT1-002461) (**REP 1:**).

<2> Remove the MOTHER-PCB-ASSEMBLY(MT1-000139) (**REP 1:**).

<3> Unplug the two terminals (**A**) from the HARNESS-DI-TOWER(MT1-002691) that is connected to the MT1-000139.

<4> Remove the MASK-MIRROR-AND-FROST-ASSEMBLY (MT1-002629) (**REP 5:**).

<5> Remove the DICE-INTERNAL-TOP-COVER(MT1-002325) (**REP 6:**).

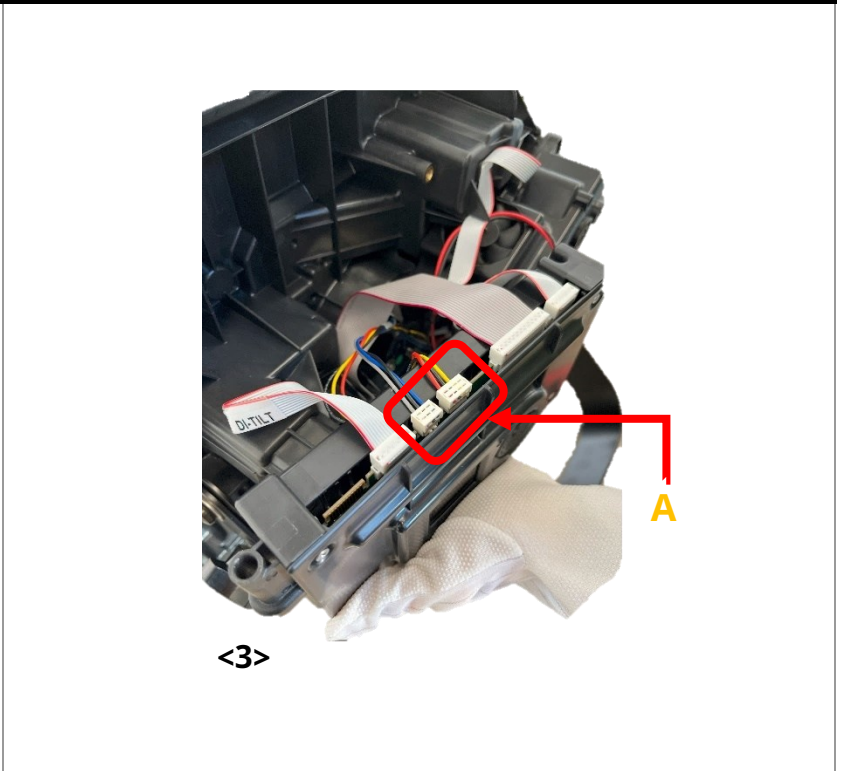

9.2

Unscrew the 4 screws MT1-001094 SCREW-M4-16-TORX(MT1-001094). using a TORX T20 screwdriver.

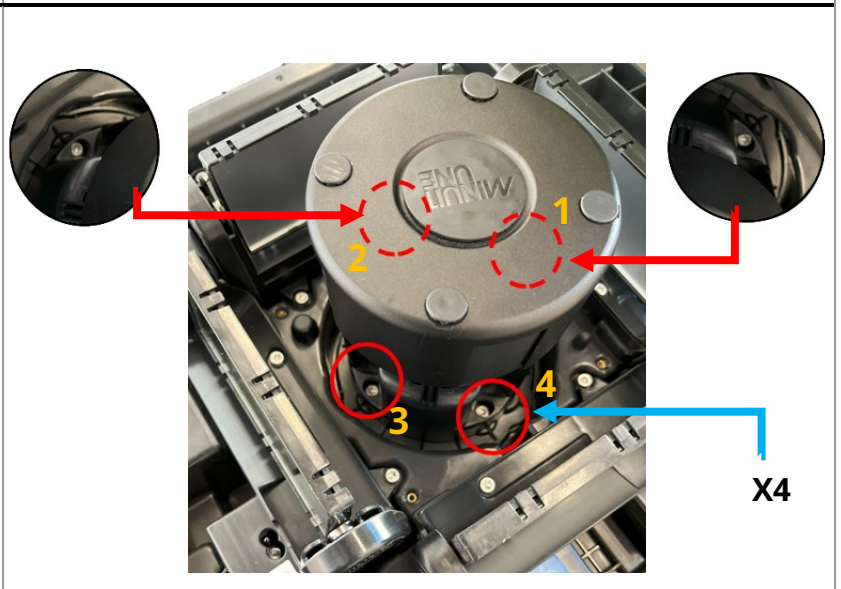

9.3

<1> Carefully **(A)** pull the **MT1-002787** while passing the **MT1-002691** harness **(B)** through the hole in the **DICE-MAIN-HOUSING-AND-INSERTS (MT1-001659)** at the same time.

<2> Use blunt tool(screwdriver E.g.) to help push the seal **(C)** around the harness(MT1-002691) if necessary.

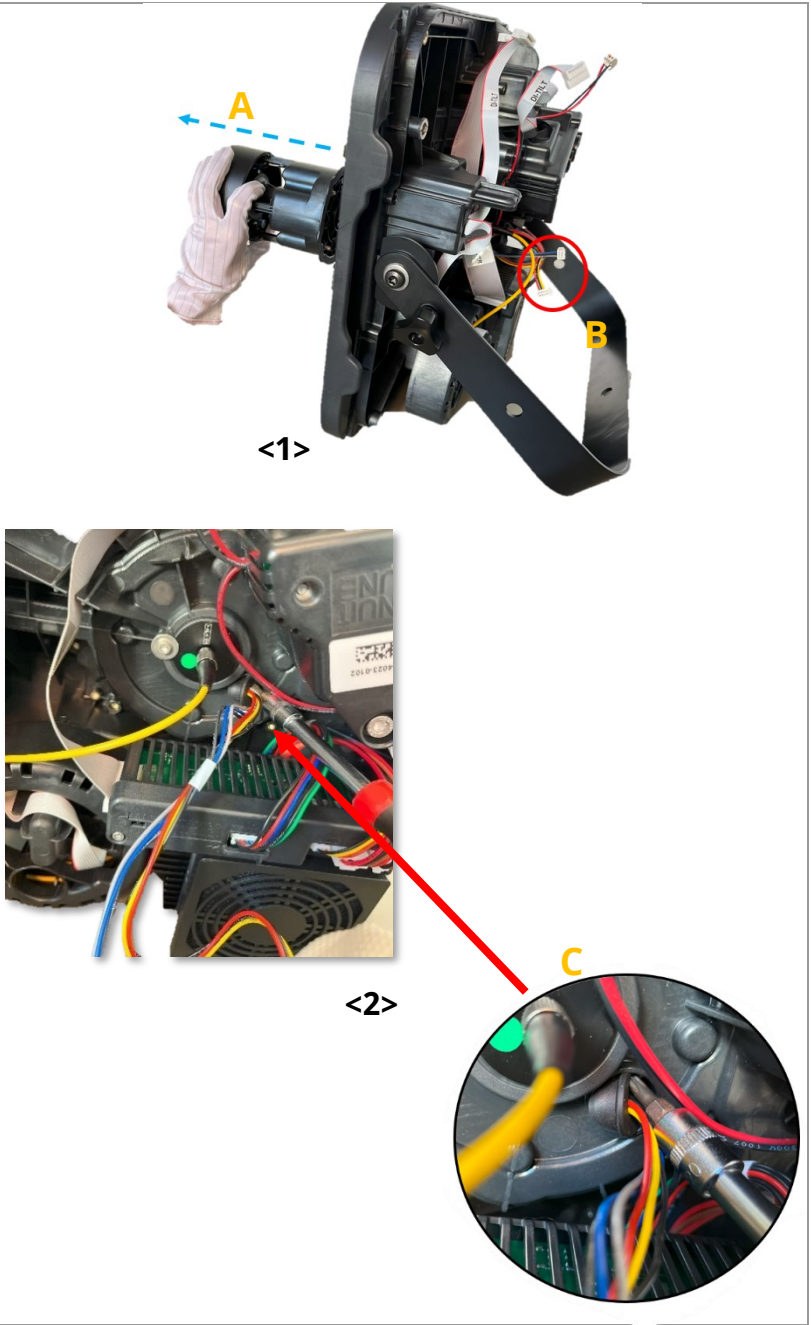

9.4

*Make sure not to lose the **CENTRAL-TOWER-SEAL (MT1-000614) (A)** under the **MT1-002787**.*



Assembly procedure:

<1> When putting the **MT1-002787** back in position, make sure to pass the connectors first, to put the harness **MT1-002691 (B)** in its place.

<2> Place the central tower module **MT1-002787** on top paying attention to the collimator **(C)**.

<3> Carefully pass the seal **(D)** that surrounds the Harness **MT1-000614** connected to the **MT1-002691** through the hole in the **MT1-001659**. Use a blunt tool to push it if necessary.

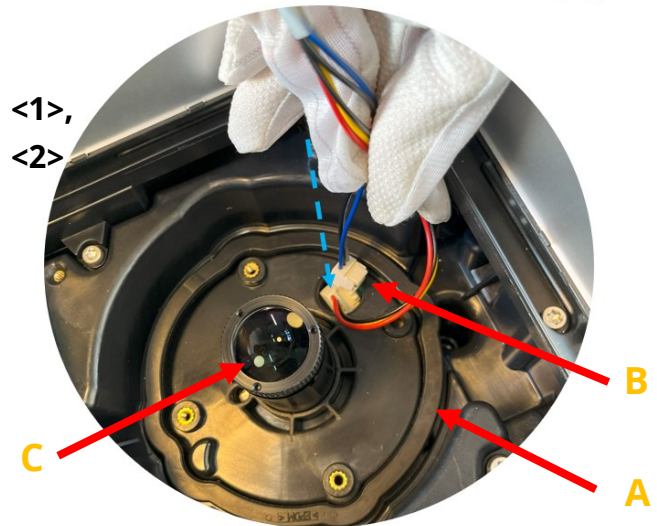

<1>, Back view

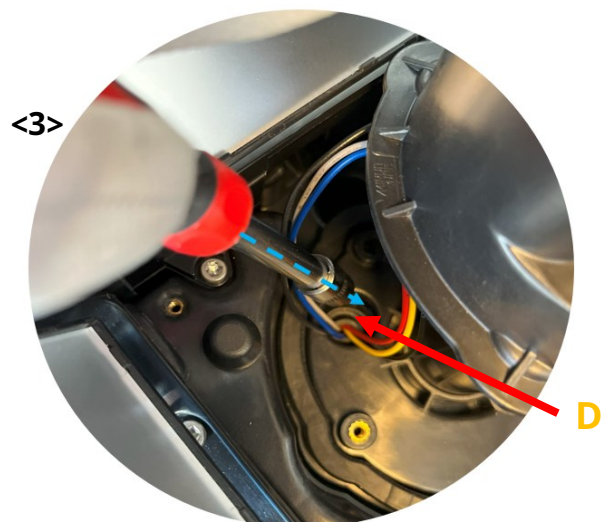

<4> Once both harness (MT1-002691) connectors have passed through the hole. Support the Tower(MT1-002787) against the MT1-001659, using the centering pin (E) at the base of it, to position it correctly.

<5> The centering pin (E) is also found in the main housing (MT1-001659).

Once the Tower (MT1-002787) positioned make sure that it is resting on its fixation point and centering pin (E).

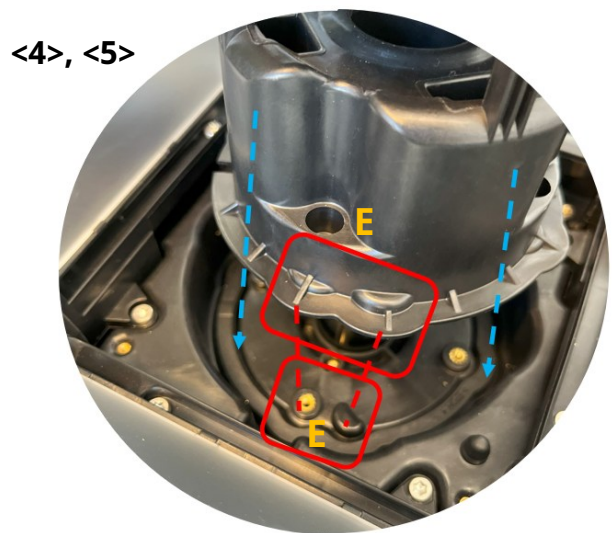
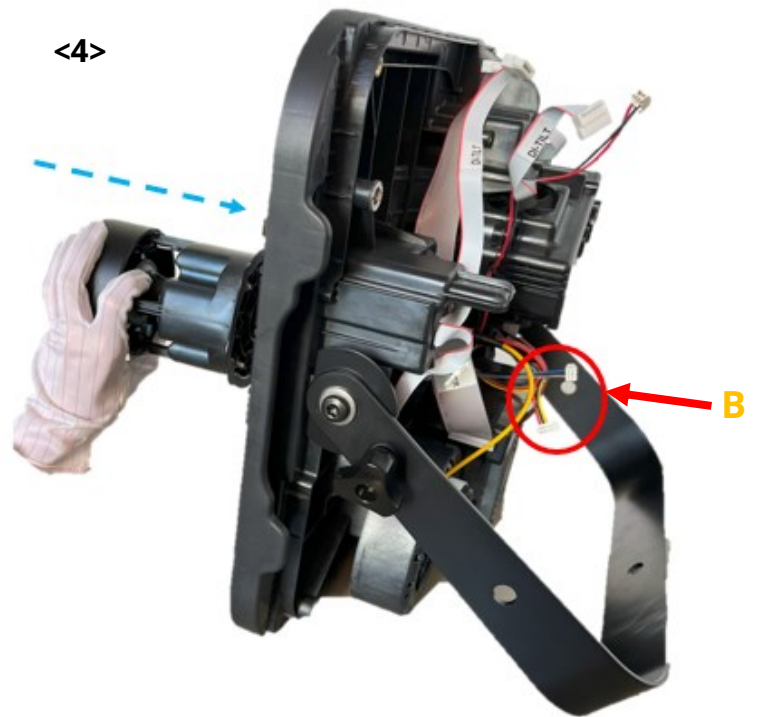

9.5

<1> After well positioning the **MT1-002787** with the help of its fixation pins, screw it back. be careful not to twist or crush the cables and position back the seal (**A**).

Tight the screws with a torque of 1.2 Nm.

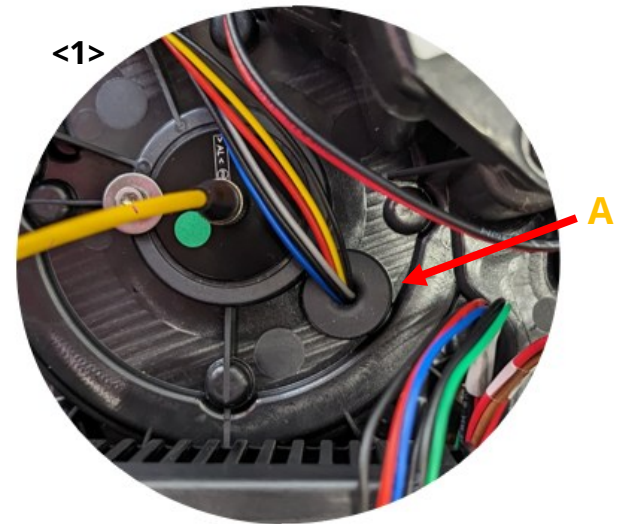
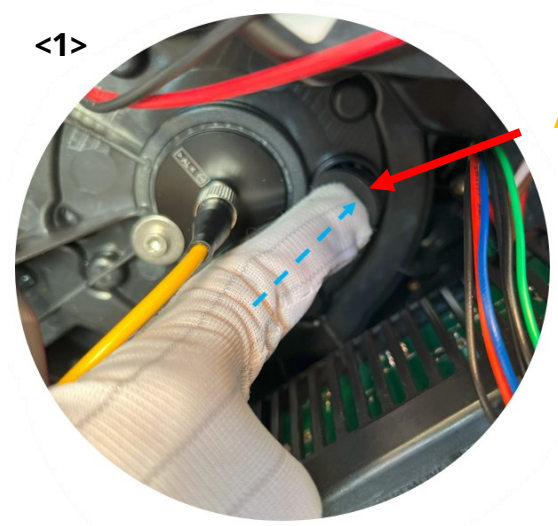

<2> Pay attention to the Harness direction when placing it back.

The PCB has a slot (**B**) indicating the direction.

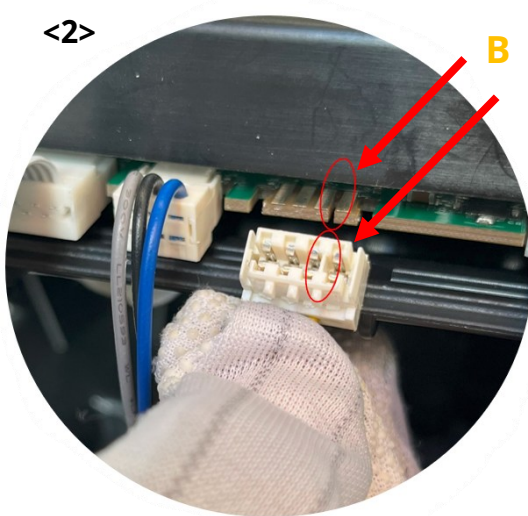

<3> Once the **MT1-002787** has been replaced, "**Plate set up**" calibration (see section **CAL 1**;) need to be performed to ensure that the laser light plan is leveled.

<p>REP 10: REPLACING DICE-YOKE (MT1-002354)</p>	<p>Tools/Equipment :</p>	<p>TORX T40 SCREWDRIVER</p>
	<p>Diagram</p> <p style="text-align: center;">⚠ CAUTION!</p> <p>Class 3R laser procedure. Avoid direct eye exposure.</p>	
<p>Instructions</p>	<p>Diagram</p>	

10.1

<1> Place the product on the DICE-TRANSPARENT-COVER (MT1-001645) on a soft surface to avoid scratching the cover.

<1>



<2> Make sure the DICE-YOKE (MT1-002354) is horizontal to the surface.

<2>

**Horizontal
To the
surface**



<1> Loosen the SQUARE-NECK-BOLT slightly on the 2 sides of the **DICE-YOKE** (MT1-002354).



10.2 <2> The goal is to ensure that the screws SQUARE-NECK-BOLT-M8-16 (MT1-002422) (**A**) with the KNOB-M8-THREADED-HOLE (MT1-002425) (**B**) are no longer pressing against the surface of the FRICTION-PLATE-AND-HOOP-FIXTURE-SUPPORT-ASSEMBLY (MT1-002765) (**C**), and the handles against the external surface of the **DICE-YOKE**.

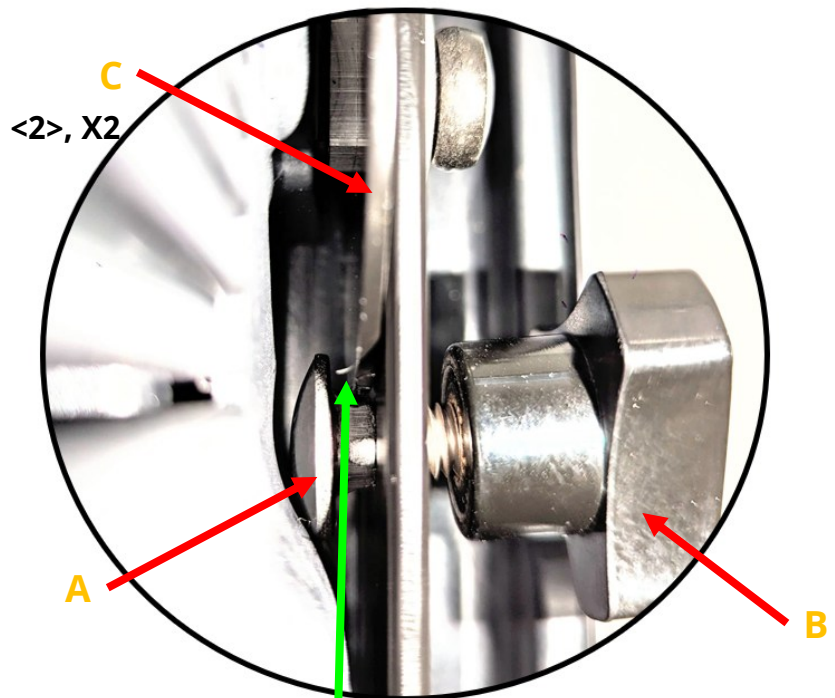

A and B are not pressing against C

10.3

<1> Unscrew the 2 MT1-003031 SCREW-M8-16-TORX .

Make sure not to lose the MT1-003032-CONTACT-WASHER-M8-L (A)



10.4

<1> Put the **DICE-YOKE** (MT1-002354) vertical to the surface.

<2> Gently separate apart the two arms of the **DICE-YOKE** and carefully remove it from the fixture.



<1>, <2>

<3> Make sure not to lose the MT1-002423-YOKE-SPACER (A) when removing the DICE-YOKE .

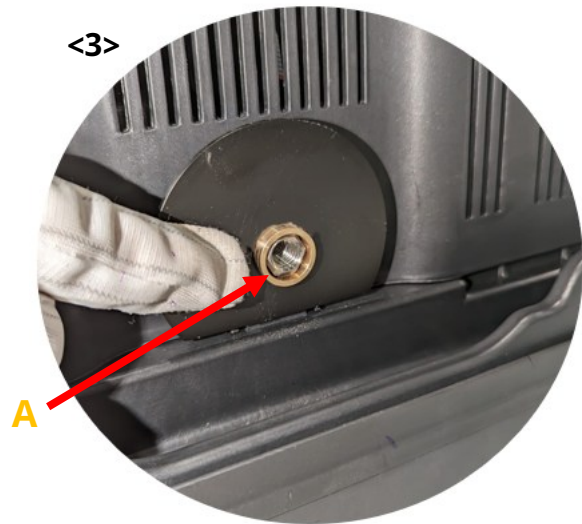

10.5

<1> Unscrew completely the KNOB-M8-THREADED-HOLE (MT1-002425) (**B**) and retrieve the MT1-002423-YOKE-SPACER (**A**) on the 2 sides of the DICE-YOKE (MT1-002354).



Assembly Procedure:

<1> Screw the 2 KNOB-M8-THREADED-HOLE (MT1-002425) (A) with the 2 screws SQUARE-NECK-BOLT on the square hole of the new DICE-YOKE (MT1-002354).

Do not screw the 2 SQUARE-NECK-BOLT (A) completely, or they will block when assembling the yoke back.

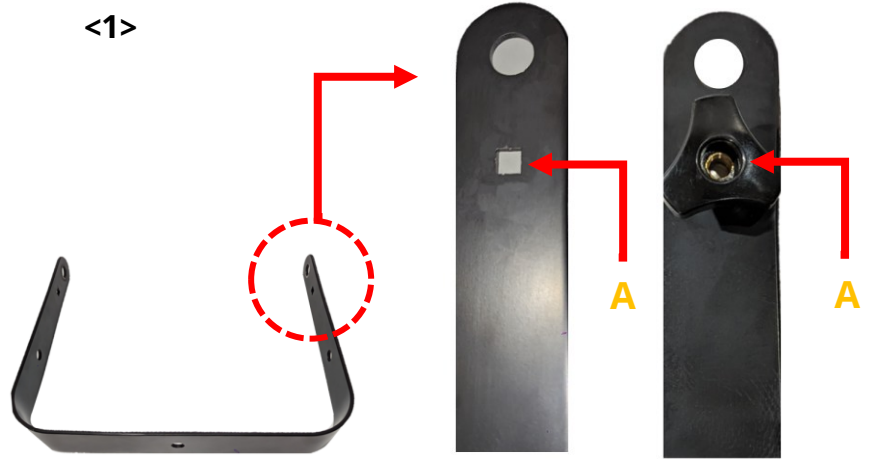

<2> put the 2 YOKE-SPACER(MT1-002423) (B) on the FRICTION-PLATE-AND-HOOP-FIXTURE-SUPPORT-ASSEMBLY (MT1-002765) (C).

Make sure not to lose the MT1-002423-YOKE-SPACER (B) when assembling on the DICE-YOKE.

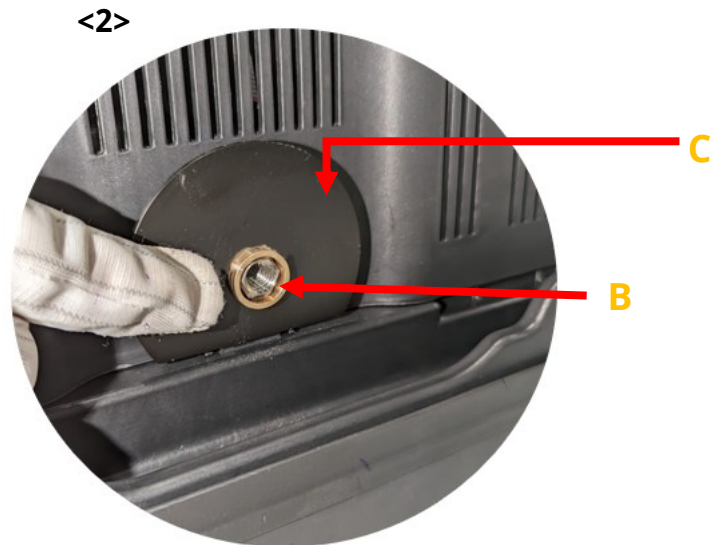

<3> Position the DICE-YOKE (MT1-002354) vertically, ensuring that the holes in the MT1-002354 are precisely aligned with the YOKE-SPACER (B).



10.6

<4> The **DICE-YOKE** is slightly wider; *it does not fit directly onto the spacers*. Tighten the 2 **KNOB-M8-THREADED-HOLE** (MT1-002425) (**A**) on each side of the yoke (first one, and then the other), until the **YOKE-SPACER** (**B**) is in the **DICE-YOKE** hole(**C**). Be careful not to tighten the **KNOB-M8-THREADED-HOLE** (MT1-002425) (**A**) completely.

<4>

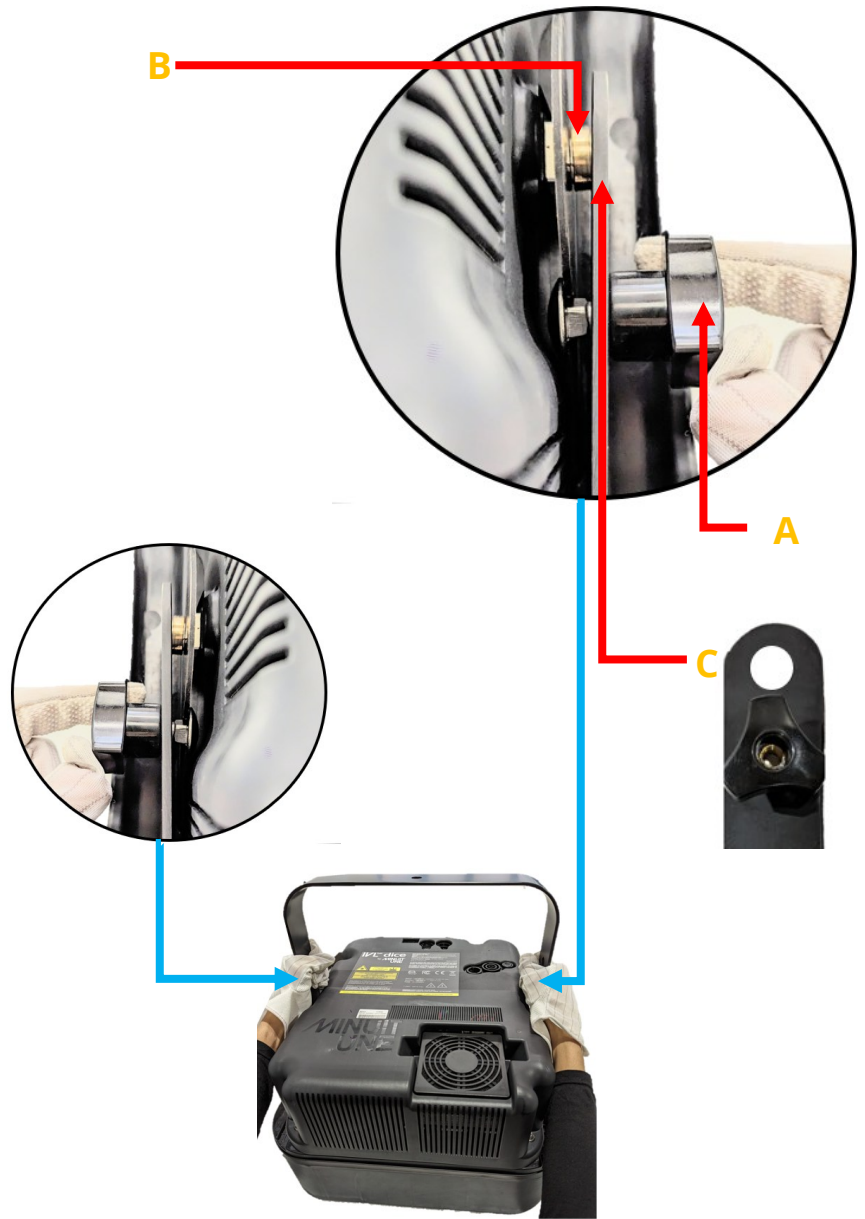

<5> Once the 2 YOKE-SPACER (**B**) are in the DICE-YOKE hole(**C**). Position the DICE-YOKE horizontally.

<5>

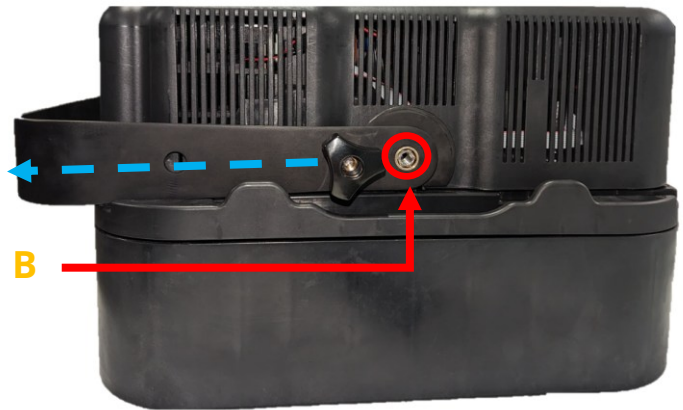



<6> Finally screw the 2 MT1-003031 SCREW-M8-16-TORX back .

*Do not forget to put the MT1-003032-CONTACT-WASHER-M8-L (**D**) before.*

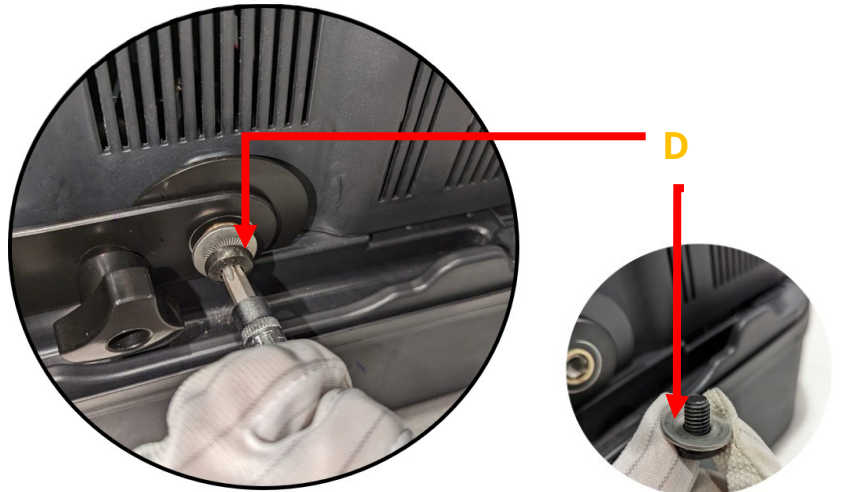

<6>



<p>REP 11: REPLACING H2-2-HARNESS-FAN (MT1-001921)</p>	<p>Tools/Equipment :</p>	<p>TORX T20 SCREWDRIVER</p>
	<div style="background-color: yellow; padding: 10px; border: 1px solid black;"> <p style="text-align: center;">DANGER</p> <p style="text-align: center;">ALWAYS TURN OFF AND DISCONNECT THE PRODUCT BEFORE OPENING THE PRODUCT OR PERFORMING THIS DESCRIBED SERVICE PROCEDURE. DANGEROUS CLASS 4 LASER RADIATION POTENTIALLY ACCESSIBLE IF THESE INSTRUCTIONS ARE NOT FOLLOWED WHICH COULD RESULT IN SEVERE EYE OR SKIN INJURY.</p> <div style="display: flex; justify-content: space-between;">   </div> </div>	

<p>Instructions</p>	<p>Diagram</p>
---------------------	----------------

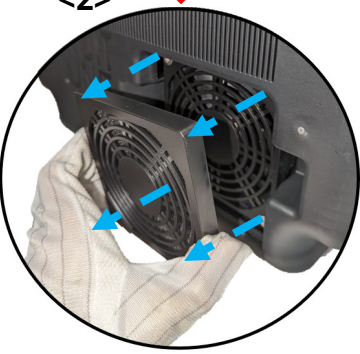
<p><i>If the fan filter and the fan are not cleaned regularly, airflow could be obstructed and will cause overheating.</i></p> <p><i>Wait for the product to cool down before performing this operation.</i></p>	<div style="display: flex; align-items: center;">  <p>BE CAREFUL WITH HEATSINK Wait for a cooling down before cleaning.</p> </div>
--	---

<p>11.1</p> <p><1> Remove the FIBER-DICE-BOTTOM-HOUSING-AND-INSERTS (MT1-002461) (REP 1:).</p> <p><2> Remove the FILTER(MT1-002405) and the FILTER-COVER (MT1-002406), you need to remove the MT1-002406 by hand.</p> <p><i>The FILTER(MT1-002405) and the FILTER-COVER (MT1-002406) can be removed before or after remove the MT1-002461.</i></p>	<div style="text-align: center;">  <p style="color: red; font-size: 24px; margin: 10px 0;">↓</p> <div style="display: flex; justify-content: space-around;"> <div style="text-align: center;"> <p><2></p>  </div> <div style="text-align: center;"> <p><2></p>  </div> </div> <p style="color: red; font-size: 24px; margin-top: 10px;">→</p> </div>
--	--

11.2

Unscrew the 4 screws M4-40-FLAT-HEAD-TORX (MT1-002408).

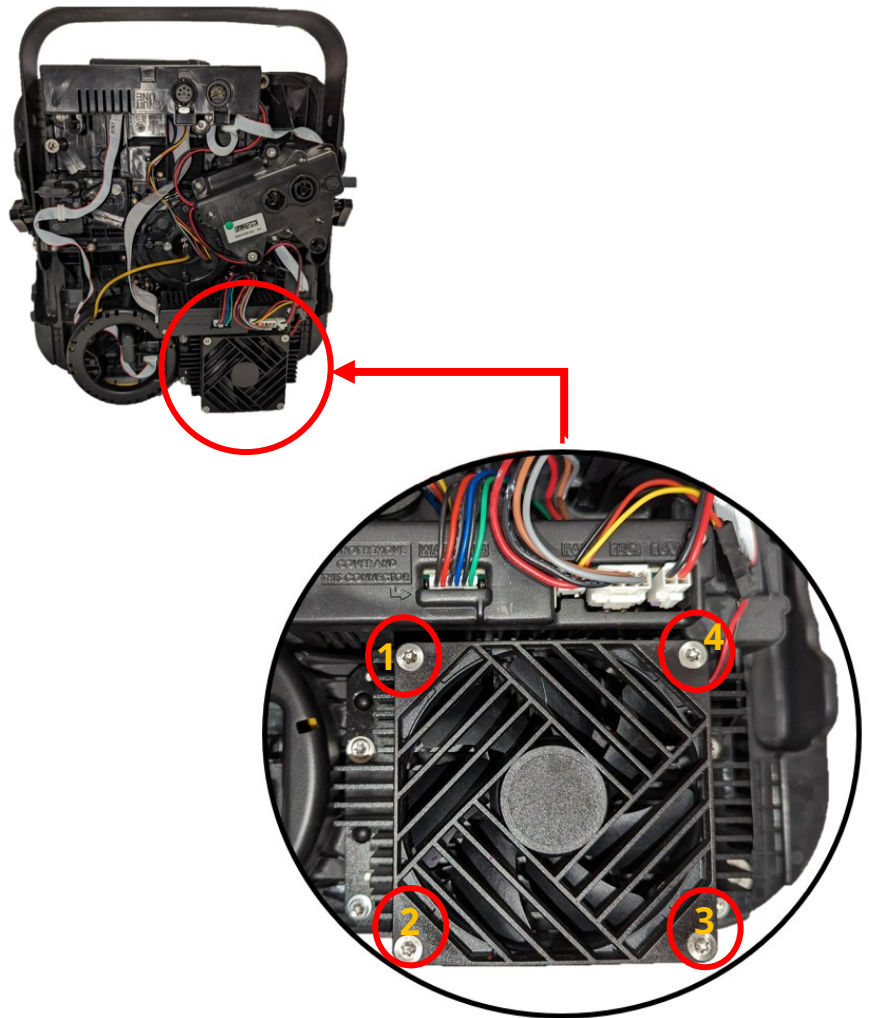

11.3

Retrieve the FINGER-GUARD(MT1-002404) (A).

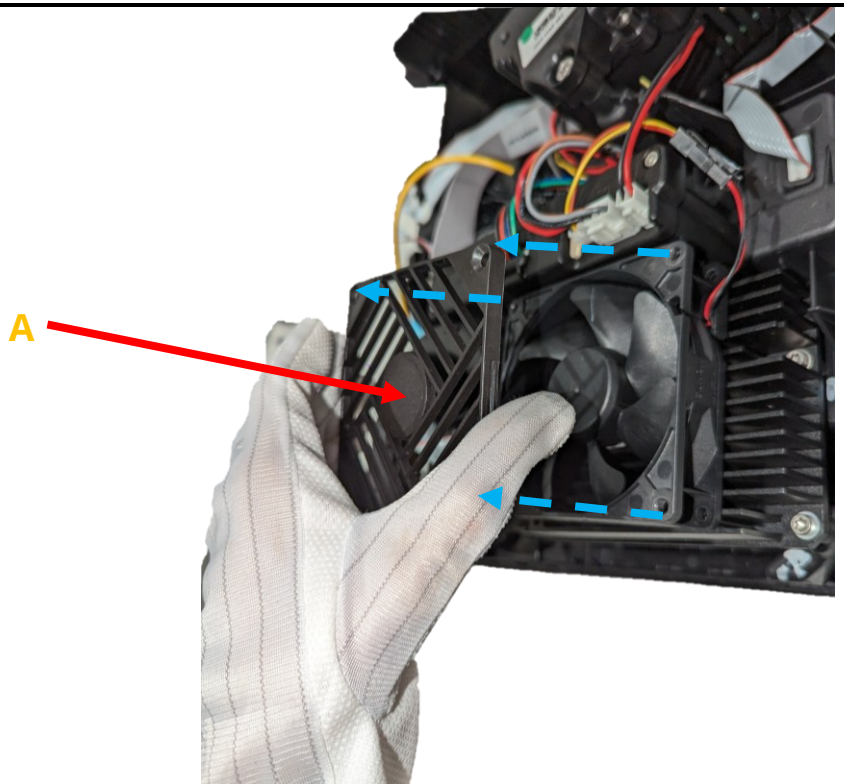

11.4

Disconnect the **H2-2-HARNESS-FAN(MT1-001921)** and remove it.

Pay attention to the direction of the fan blades and the connector when putting it back.

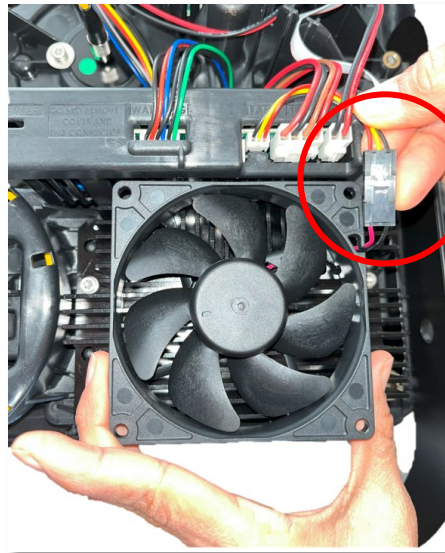

11.5

- <1> Connect the **H2-2-HARNESS-FAN(MT1-001921)** back paying attention to its direction.
- <2> Position the **H2-2-HARNESS-FAN(MT1-001921)** back to its position.
- <3> Position the **FINGER-GUARD(MT1-002404)** back to its position(on the **MT1-001921**).
- <4> Screw the 4 **M4-40-FLAT-HEAD-TORX (MT1-002408)**
- <5> Put back filter and filter cover

CALIBRATION

<p>CAL 1: SET UP PLATE CALIBRATION</p>	<p>Tools/Equipment:</p>	<p>-6 mm Allen wrench. -TrueCon1 cable.</p>
	<div style="display: flex; align-items: center;">  <div style="border: 1px solid black; padding: 5px; background-color: white;"> <p style="color: red; margin: 0;">⚠ DANGER</p> <p style="margin: 0;">Class 4 laser radiation.</p> <p style="margin: 0; font-size: small;">Avoid eye or skin exposure to direct or scattered radiation.</p> </div> </div> <p style="margin-top: 10px;">Do not wear bracelets, rings, smartwatches, or reflective objects during this procedure.</p>	
<p>Procedure purpose</p>	<p>Level the laser light plan .</p>	
	<p style="text-align: center;">Instructions</p>	<p style="text-align: center;">Diagram</p>
<p>1.1</p>	<p><1> Remove the DICE-TRANSPARENT-COVER (MT1-001645) (REP 4:)</p> <p><2> With the help of a flat head screwdriver unclip the 4 SCREW-MASK (MT1-001600) on the top of the MT1-002787.</p>	

1.2

<1> Plug the power cable and turn the fixture ON.



<1>

<2> After the fixture's reset with your hand, place **ALL** the Tilts (MT1-000935) horizontally, with the frosted side (**A**) facing upwards.

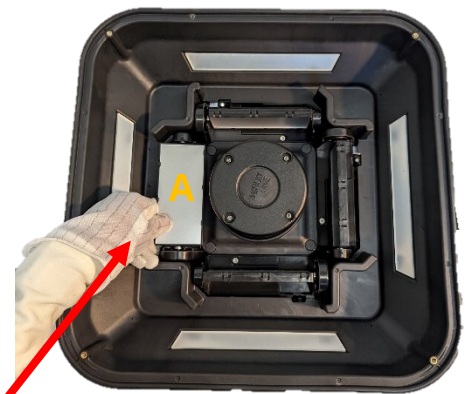

X4

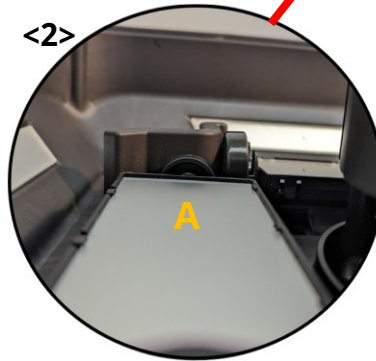

<2>

1.3

Press the knob near the screen panel of the fixture and go to **Service> Calibration> Plate set up.**

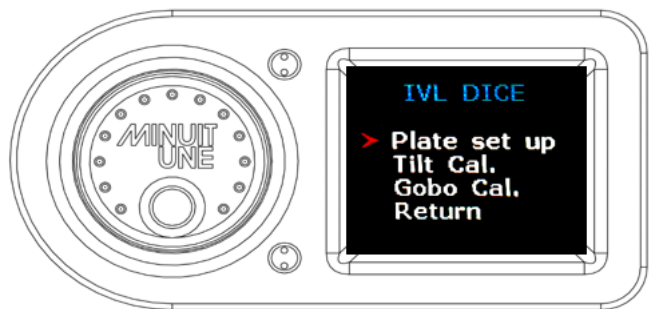

1.4

The goal is to position the laser plane *as much as possible* below the upper edge (green dotted line) of the four MIRROR-MASK-FROST (MT1-002638) of the MT1-002639.

Tip: Use a white paper sheet to enhance visibility of the beam.

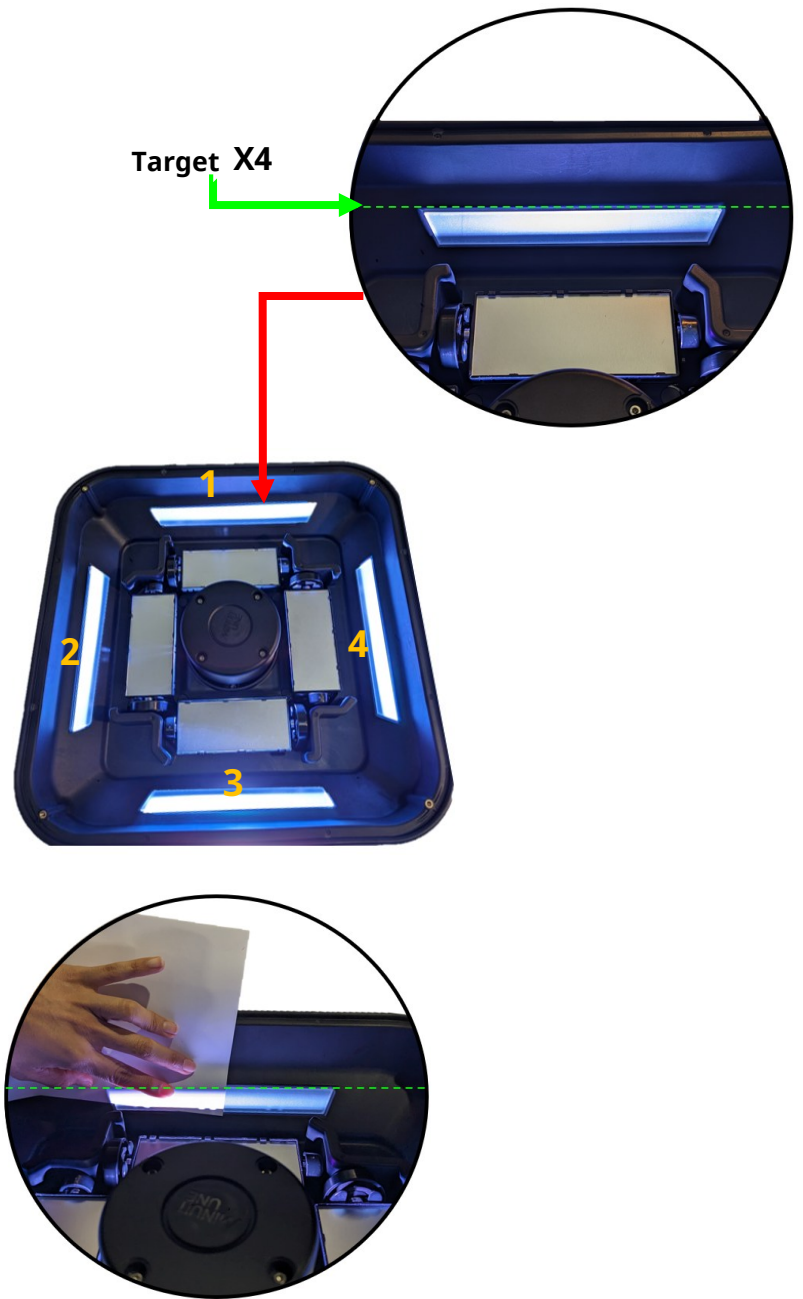

Calibration procedure:

* Do every operation clockwise to perform this calibration.

<1> On the top of the tower(MT1-002787), screw and unscrew the pair of screws(MT1-001173) **A** or **B** in front of the MT1-000935 (Previously placed horizontally) that requires adjustment to level the beam.

In the example shown in the image, the pair of screws(MT1-001173) to be tightened are labeled as A.

<2> Before moving to the next mirror always ensure the screws aren't loose and move clockwise.

<3> Repeat the process, changing to the next MT1-000935, until the laser beam has no inclination and is properly aligned below the upper edge of the four frosted surfaces(MIRROR-MASK-FROST MT1-002638) (**C**) of the MT1-002639.

1.5

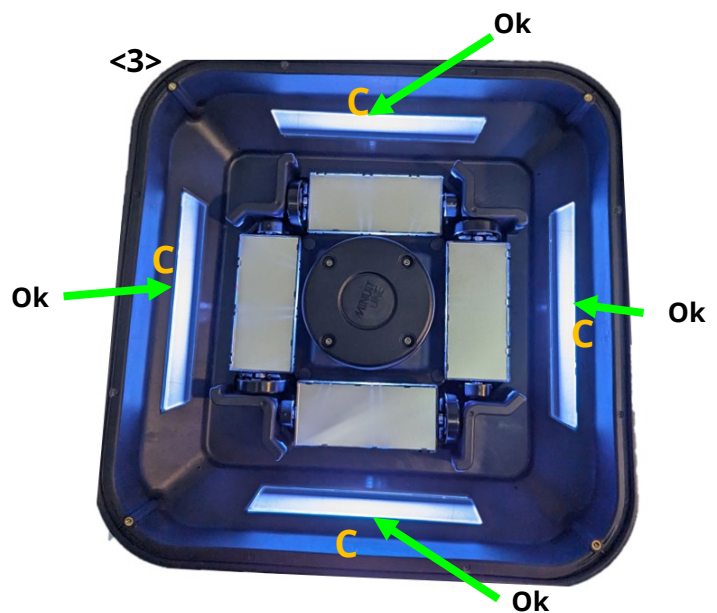
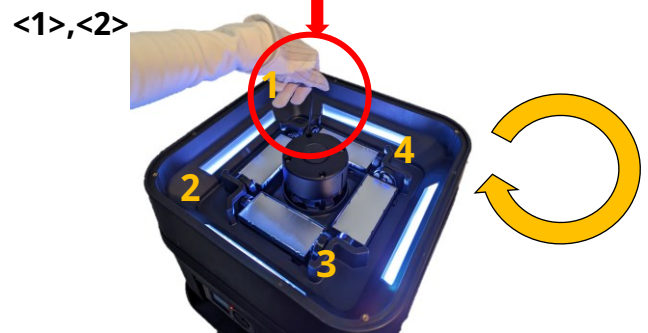
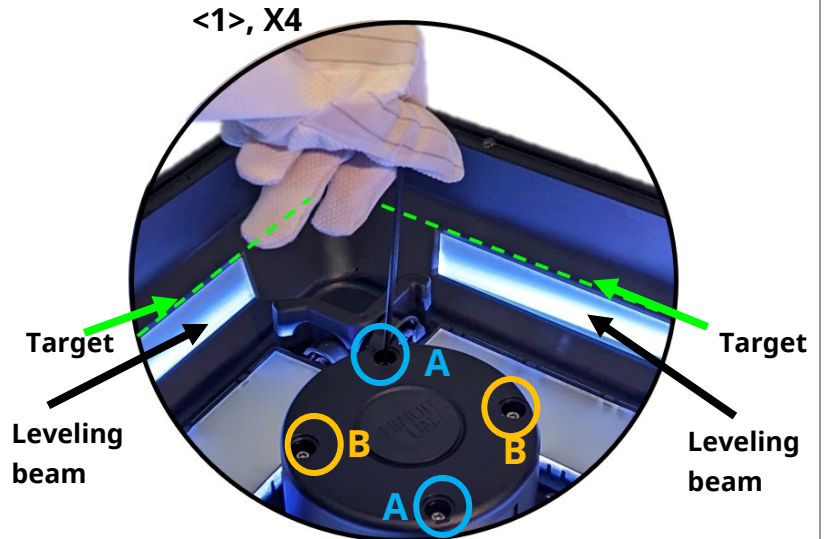

<4> Once the laser's plan is calibrated and projecting flatness in all the 4 frosted surfaces(MT1-002638) of the main housing (MT1-002639), verify the adjustment of the screws(MT1-001173) to ensure the screws aren't loose. Gently tighten them if needed, being careful not to alter the calibration.

<4>, X4

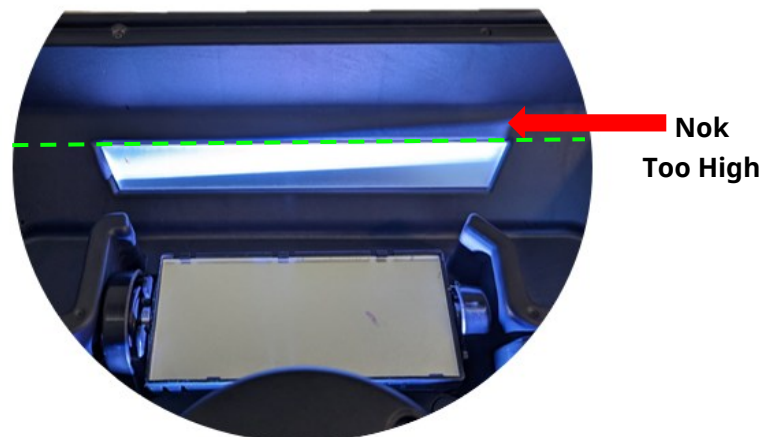
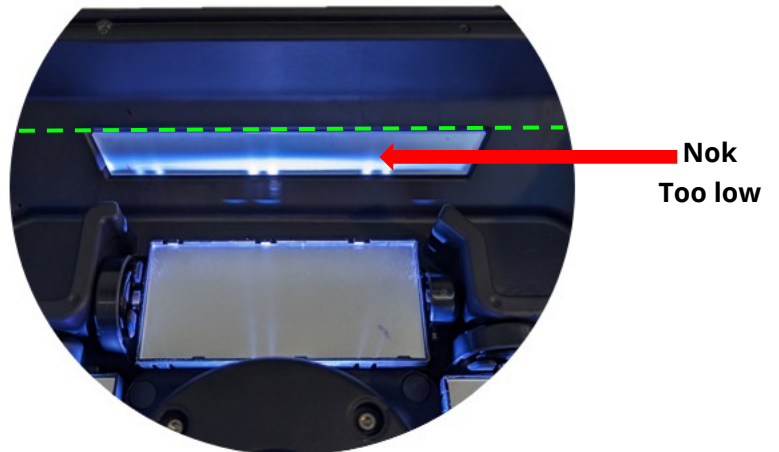
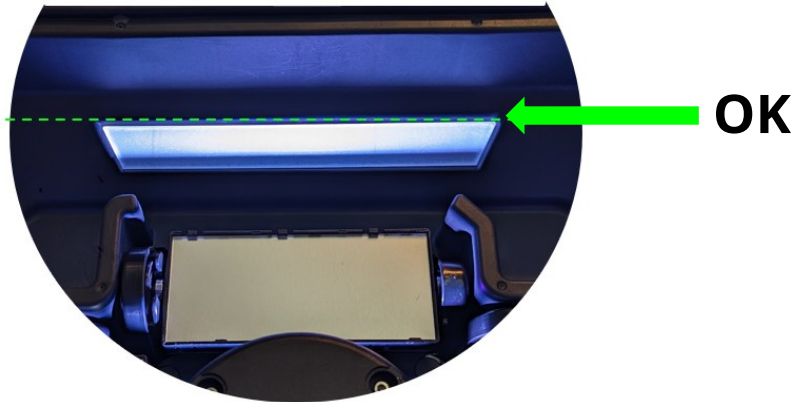

1.6

<1> Check one last time that each screw (MT1-001173) is well flattened and **tightened** at the end of the adjustment and put back the MT1-001600 on the tower(MT1-002787).

Make sure they are firmly clipped in.

It's important to tighten these screws well. If they're loose, the product might make noise when it's running.

<2> Click "return" on the menu to finish the calibration.

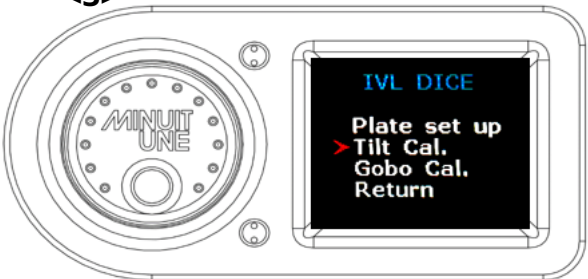
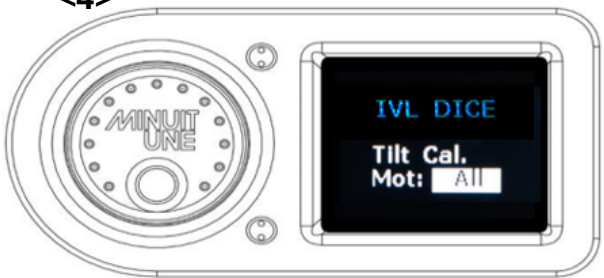

<p>CAL 2: TILT CALIBRATION</p>	<p>Tools/Equipment:</p>	<p>TrueCon1 cable</p>
<p style="text-align: center;">⚠ CAUTION!</p> <p style="text-align: center;">Class 3R laser procedure. Avoid direct eye exposure.</p>		
<p>Procedure purpose</p>	<p>Ensure that each LATERAL-BELT-ACTUATOR-ASSEMBLY(MT1-000935) has the same angle and position origin.</p>	
	<p>Instructions</p>	<p>Diagram</p>
<p>2.1</p>	<p><1> Make sure that the DICE-TRANSPARENT-COVER (MT1-001645) is in place.</p> <p><2> Plug the power cable and turn the fixture ON.</p> <p><3> Press the knob near the screen panel of the fixture and go to Service> Calibration> Tilt cal.</p> <p><4> There is the option to calibrate all the 4 Tilts (MT1-000935) or only the MT1-000935 that requires it or has been replaced.</p>	<p><2></p>  <p><3></p>  <p><4></p> 

Calibration procedure:

<1> Once the calibration has started, Tilt(MT1-000935) #1 (A) will face its mirror side in front of the light source, while all the other Tilts (B) will be facing the source with their frost side.

<2> Turn the knob to control the position of the Tilt.

<3> Position the mirror so that the reflected beam touches the opposite edge of the MASK-MIRROR-AND-INSERTS(MT1-002639) without touching the DICE-TRANSPARENT-COVER (MT1-001645), **Target.**

Once the beam is in the target position, press the knob to confirm the selected Tilt(MT1-000935) position. The calibration of the next Tilt will start (if applicable).

The screen displays the offset position and the number of the Tilt (MT1-000935) being calibrated. Note that each MT1-000935 can have a different offset position.

2.2

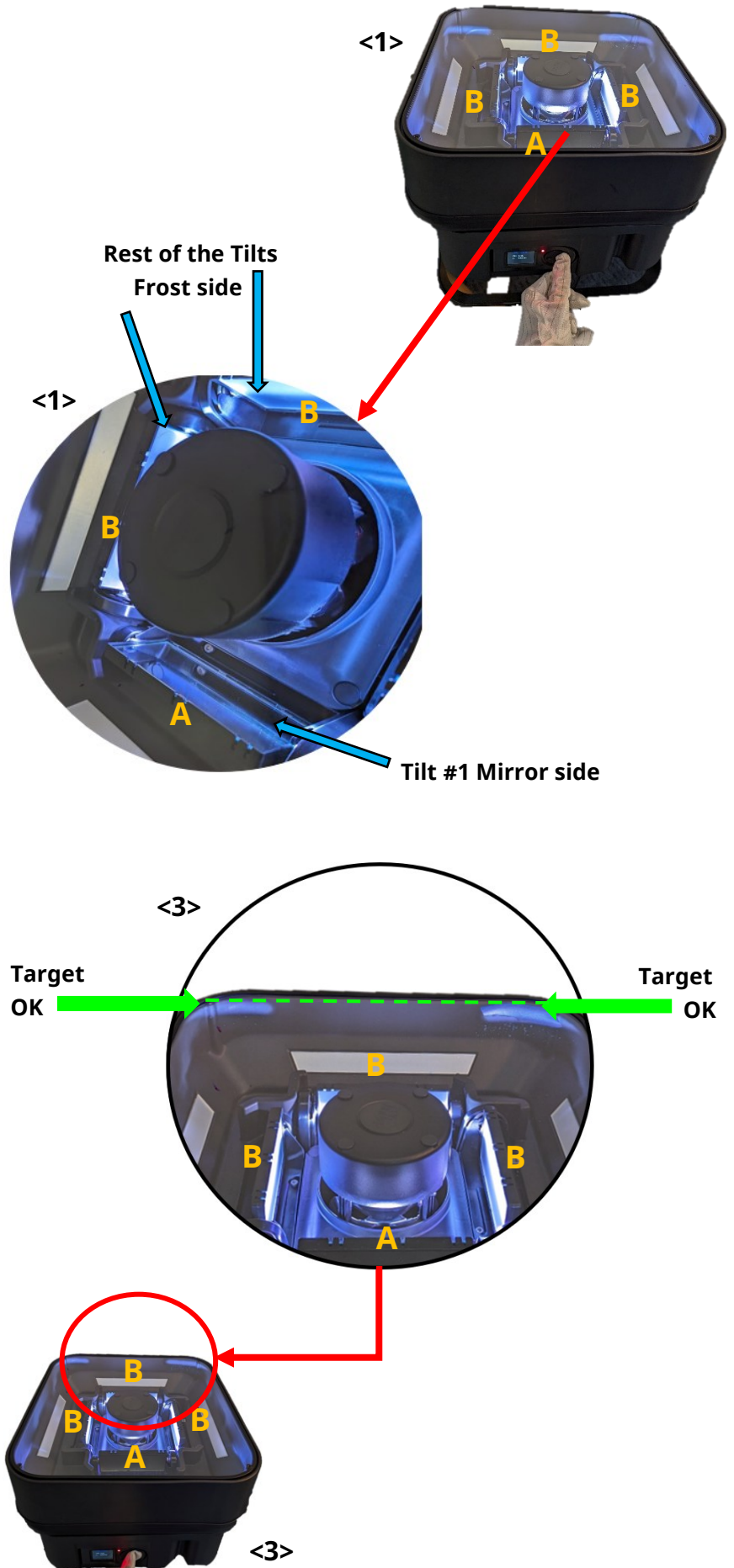

<4> Make sure that the beam in not too low .

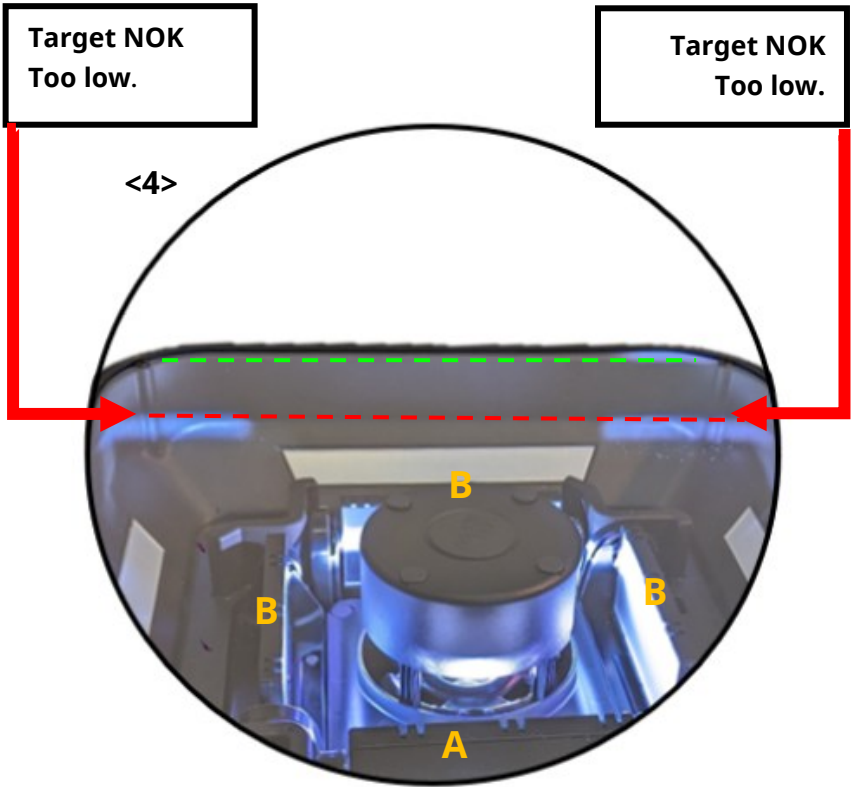

<5> Make sure that the beam in not too High .

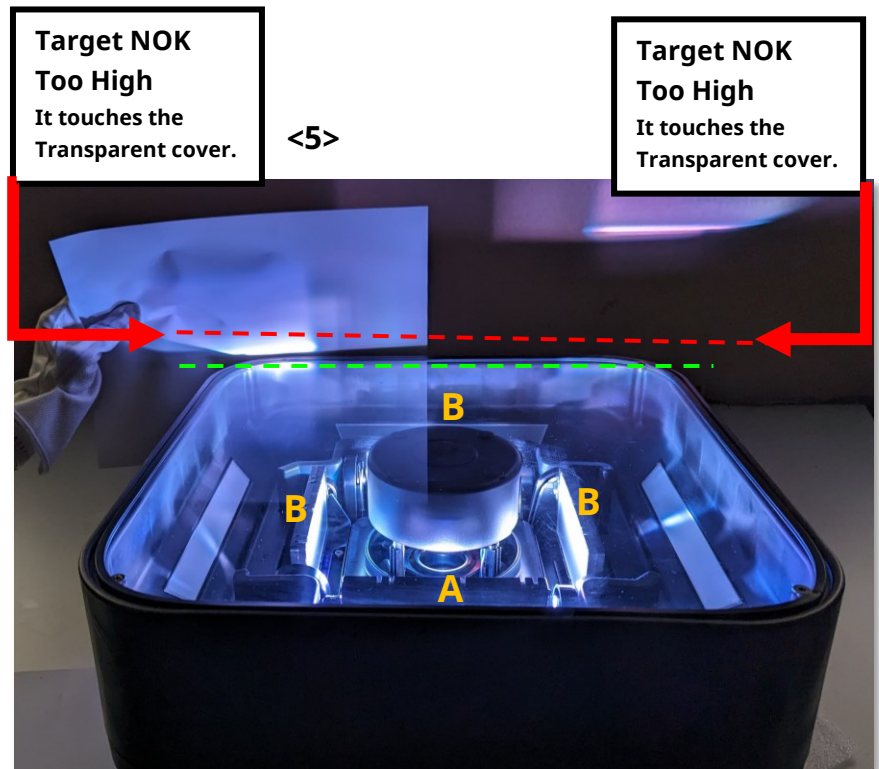

<p>2.3</p>	<p><1> Repeat the previous calibration procedure 2.2 on all mirrors(if applicable).</p> <p><2> At the end of the calibration, the mirrors will return to their defined positions.</p> <p><3> To verify that all 4 mirrors are properly calibrated, the beam should touch all four edges of the MASK-MIRROR-AND-INSERTS(MT1-002639) without touching the DICE-TRANSPARENT-COVER (MT1-001645).</p>	
<p>2.4</p>	<p>Once the calibration is completed, the end calibration screen will appear. Click on 'Save'.</p> <p><i>Please note that if you click on 'Return', the calibration will not be saved, and you will have to start the calibration process again.</i></p>	

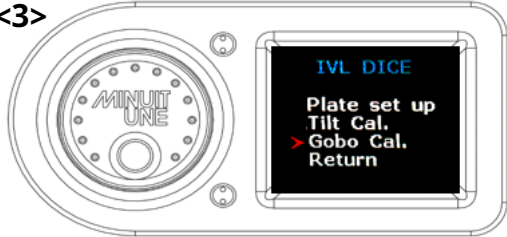
CAL 3: E-GOBO CALIBRATION	Tools/Equipment: TrueCon1 cable	
	⚠ CAUTION! Class 3R laser procedure. Avoid direct eye exposure.	
Procedure purpose	Calibrate the origin of the light plan.	
	Instructions	Diagram
3.1	<p><1> Make sure that the DICE-TRANSPARENT-COVER (MT1-001645) is in place.</p> <p><2> Plug the power cable and turn the fixture ON.</p> <p><3> Press the knob near the screen panel of the fixture and go to Service> Calibration> Gobo cal.</p>	<div style="text-align: center;"> <p><2></p>  </div> <div style="text-align: center; margin-top: 20px;"> <p><3></p>  </div>

3.2

<1> Once the calibration has started, the beam will appear divided into two colors.

<2> The **junction** of two colors between the **Tilt(MT1-000935) #1** and the **Tilt(MT1-000935) #2** will be used as a guide for this calibration.

<3> The **Target position** is represented by positioning the beam **junction** on the imaginary black dotted line on The **Tilt #1**.

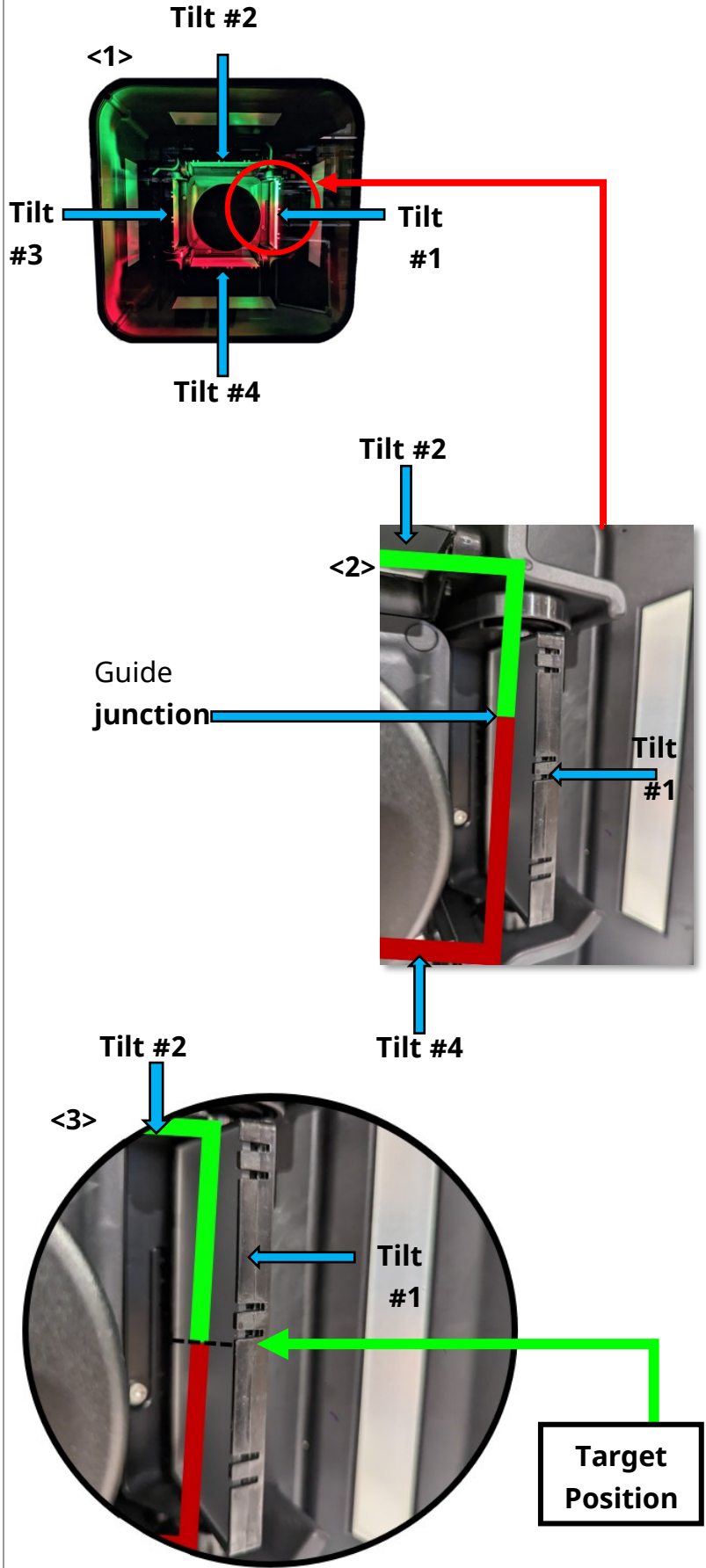

<4> Turn the knob until the guide **junction** of the two colors is positioned on the target .

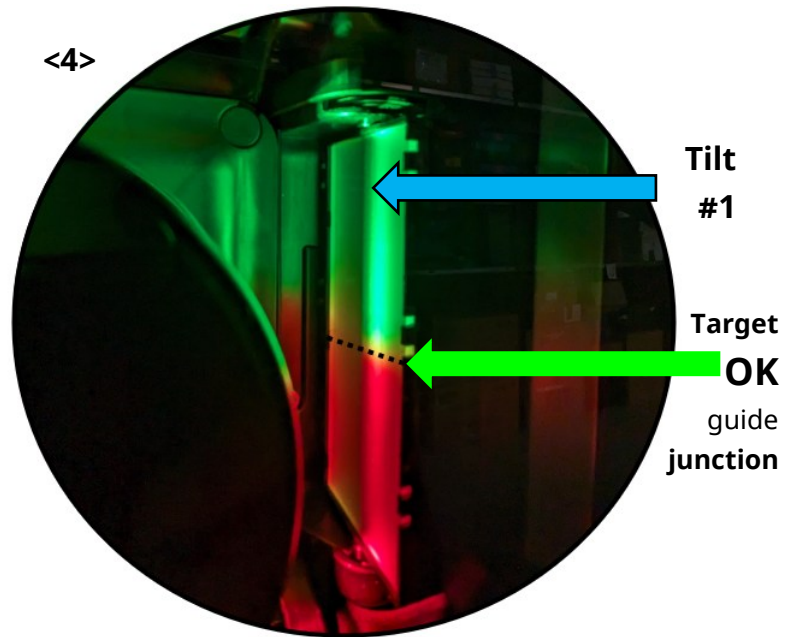

Graphic image for a better understanding.

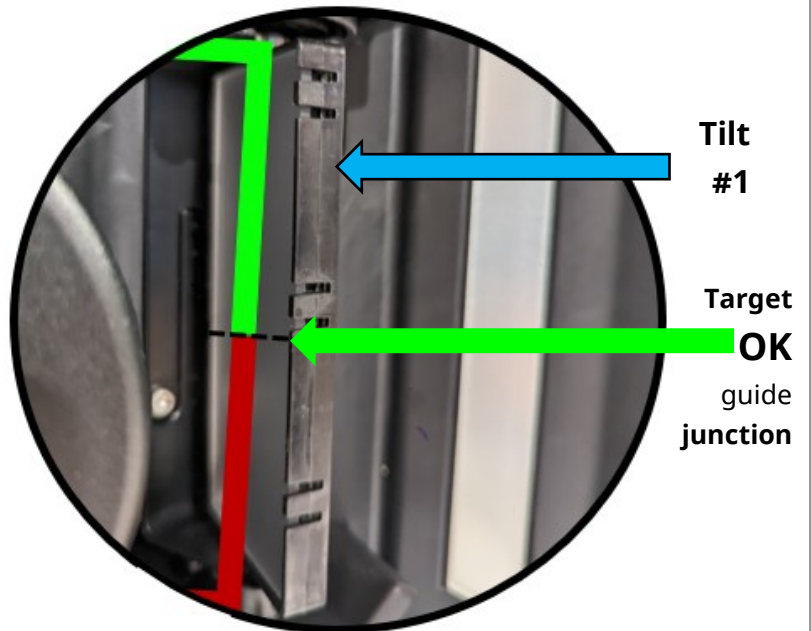

<5> Make sure that the **junction** of the colors is not too high or too low.

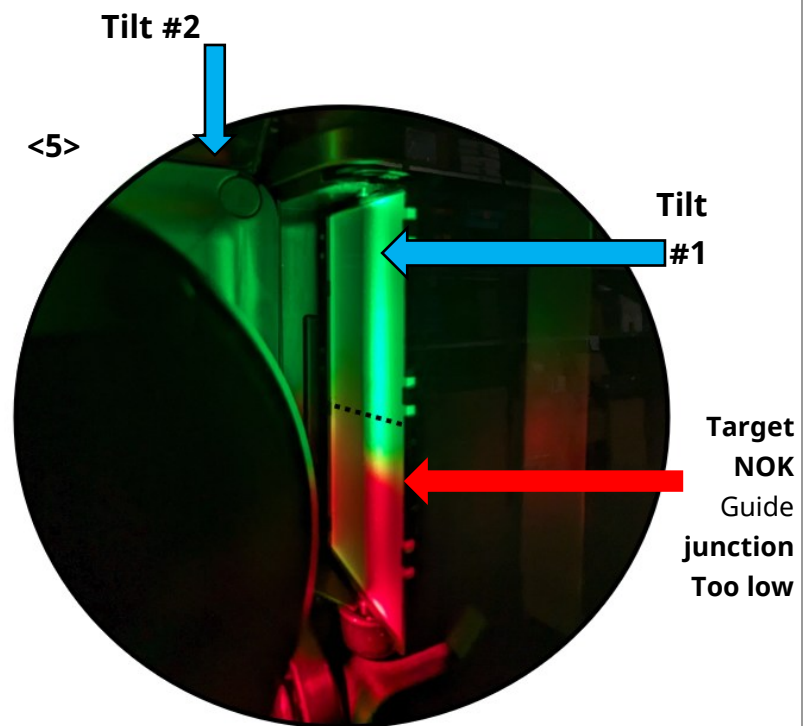
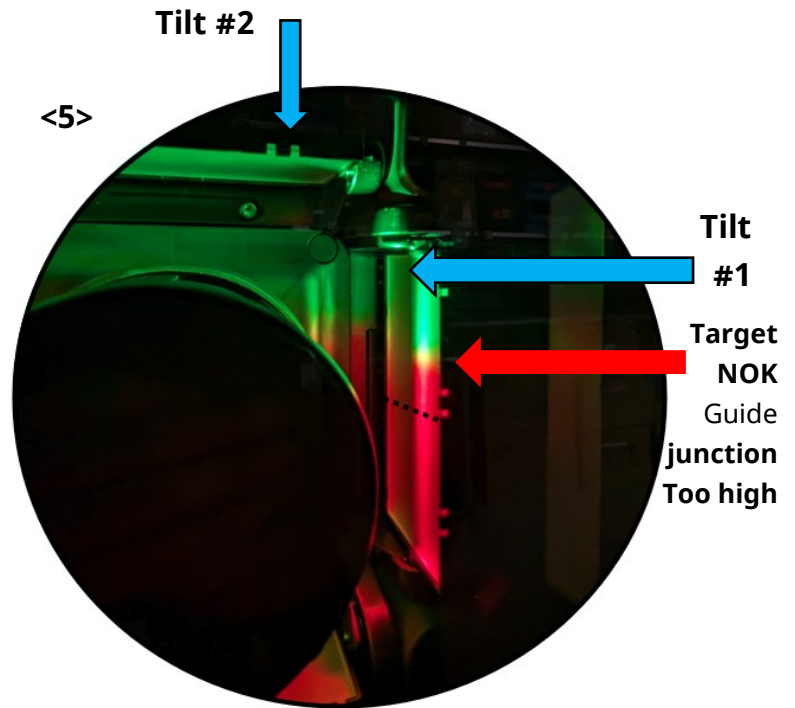

3.3

Once the calibration is completed, click the knob, and then click on 'Save'.

Please note that if you click on 'Return', the calibration will not be saved, and you will have to start the calibration process.

TESTING

TEST 1: Test General		Tools/Equipment: TrueCon1 cable
		CAUTION! Class 3R laser procedure. Avoid direct eye exposure.
Test purpose	Test and verify the operation of the main actuators quickly and generally.	
	Instructions	Diagram
1.1	<p><1> Make sure that the DICE-TRANSPARENT-COVER (MT1-001645) is in place.</p> <p><2> Plug the power cable and turn the fixture ON.</p> <p><3> Press the knob near the screen panel of the fixture and go to Service> Autorun> Test General.</p> <p><4> The screen 'Test General' appears, wait for the laser to turn on.</p>	<p><2></p> <p><3></p> <p><4></p>

<1> Press the knob, The test screen 'Play TILT: 1' is displayed, it is used to test TILT 1.

Tilt sequence:

- a. Beginning in Frost side position.
- b. 315° outward rotation.
- c. 45° inward rotation.
- d. 45° outward rotation
- e. End in Frost side position.

**The blue arrow is only indicative of an outward movement, and the yellow arrow is only to indicate an inwards movement.*

1.2

<2> Click the knob (BP on the screen) to exit the current tilt verification sequence and move on to the verification of the next tilt.

Repeat this process 4 times to test all 4 tilts.

Remember the number assigned to the mirrors (MT1-000935) is also engraved on the fixture structure.

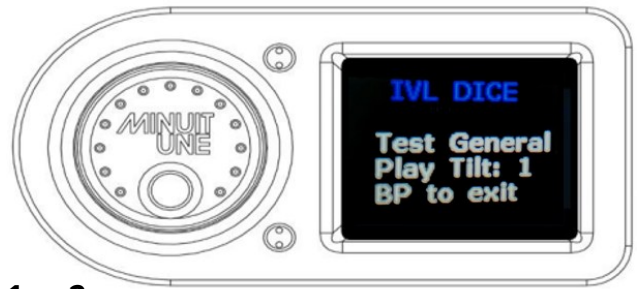

<1>,<2>

Example for Tilt #1

- b. 315° outward rotation.
- c. 45° inward rotation.
- d. 45° outward rotation.

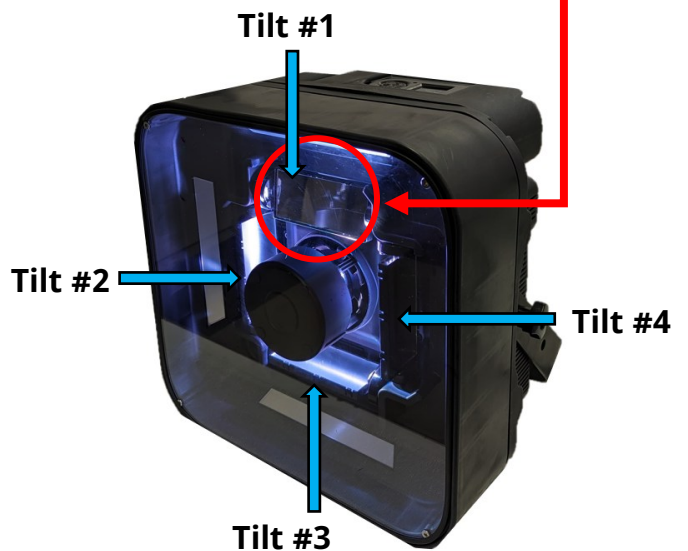
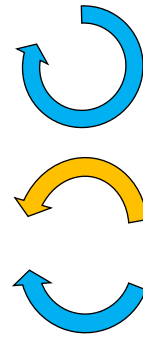

1.3

<1> The test screen 'Check Tilt' is to verify that after testing the four Tilts(MT1-000935). They will be set to position 0 to verify that they are calibrated and that their original position has not been modified (due to mechanical failure or part replacement).

<2> Remember the beam should touch all four edges of the MASK-MIRROR-AND-INSERTS(MT1-002639) without touching the DICE-TRANSPARENT-COVER (MT1-001645).

<1>

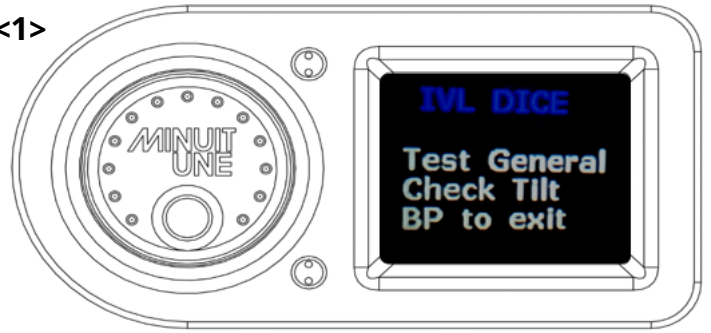

1

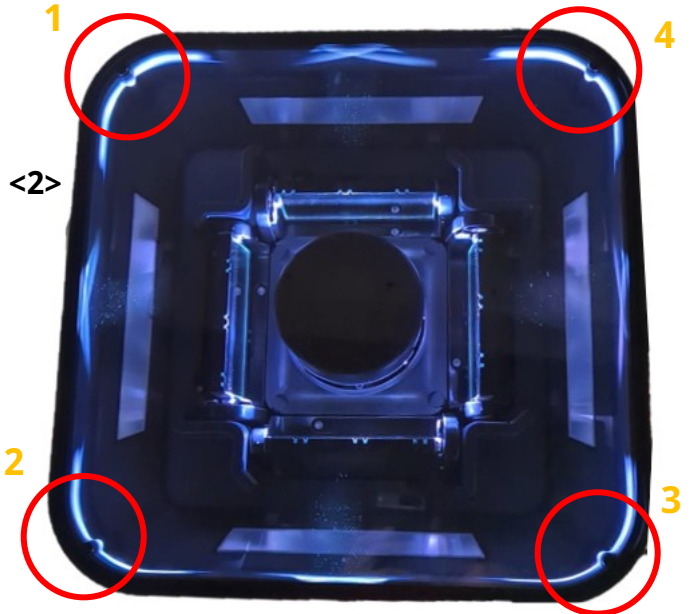

<2>

1.4

press the knob to exit the current tilt check screen and go on to the next testing step.

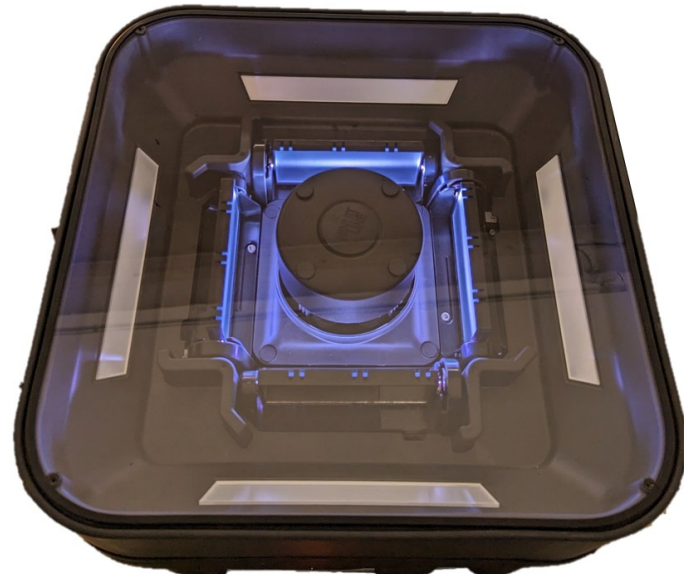

1.5

<1> The test screen 'Test Laser' is now displayed, it is used to test the laser's RGB colors.

<2> Click the knob, gobos are tested from 1 to 256.

Check that the dotted lines are well-defined and that the beam does not tremble.

< 3 > Click the knob, the mirrors will pivot to project the laser onto the DICE-TRANSPARENT-COVER (MT1-001645) . A square pattern will appear, composed of 4 colors: **white/violet**, **blue**, **red**, and **green**.

Check: The 4 colors appear clearly and are distinct (no blending).

*Check: The **green** and **red** colors must be projected onto **Tilt #1**.*

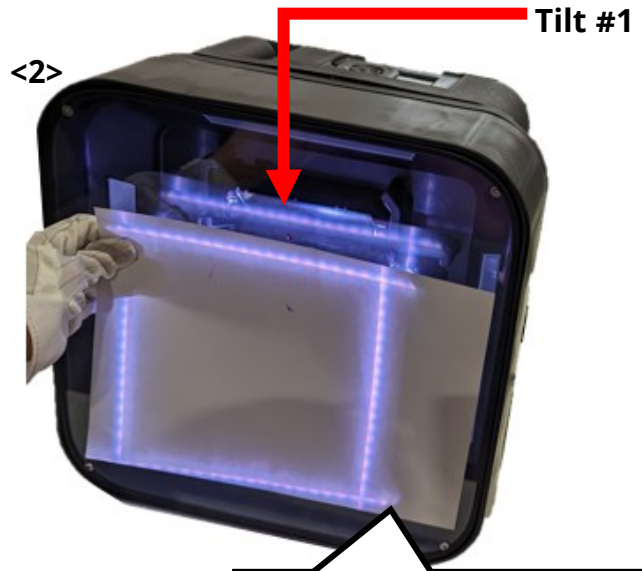
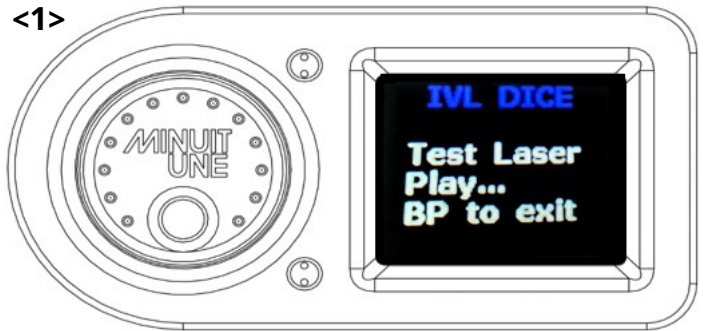

Tip: Cover the TRANSPARENT-COVER with a foam sheet or white paper to avoid looking up at the ceiling.

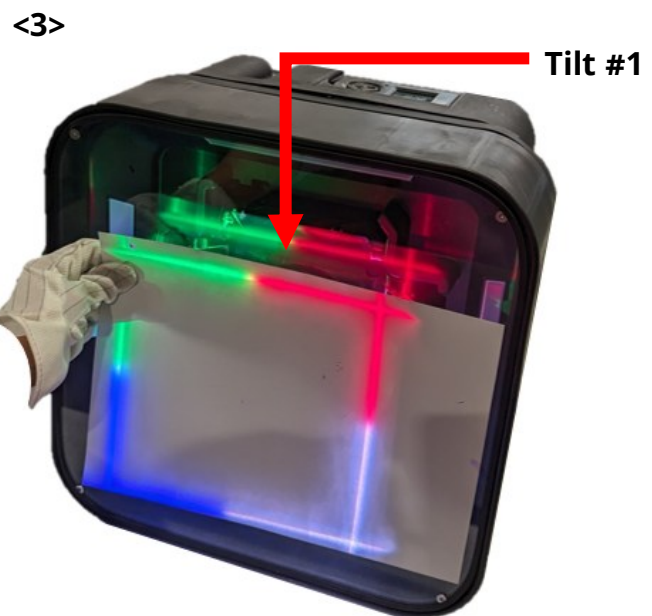

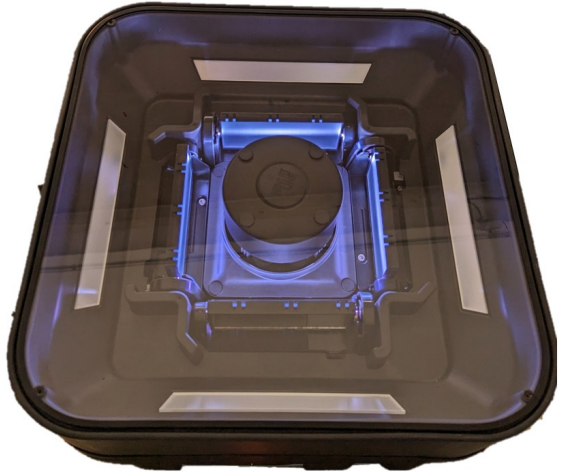
<p>1.4</p>	<p>Tilts change by placing their frosted side in front of the light source like step 1.4 in this same procedure. Afterwards, the sequence is repeated.</p>	
-------------------	---	--

<p>TEST 2: Test Laser</p>	<p>Tools/Equipment:</p>	<p>TrueCon1 cable</p>
	<p style="text-align: center;">CAUTION!</p> <p style="text-align: center;">Class 3R laser procedure. Avoid direct eye exposure.</p>	

<p>Test purpose</p>	<p>Test and verify the operation of the laser module (Gobo and colorimetry).</p>
----------------------------	--

	<p>Instructions</p>	<p>Diagram</p>
--	---------------------	----------------

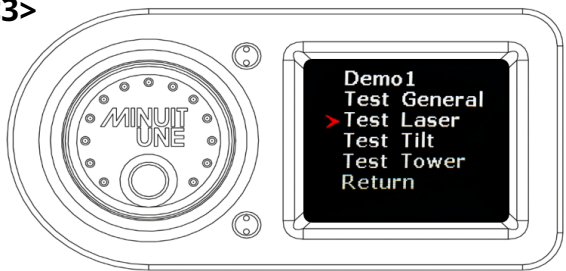
<p>2.1</p>	<p><1> Make sure that the DICE-TRANSPARENT-COVER (MT1-001645) is in place.</p> <p><2> Plug the power cable and turn the fixture ON.</p> <p><3> Press the knob near the screen panel of the fixture and go to Service> Autorun> Test Laser.</p>	<p><2></p>  <p><3></p> 
-------------------	---	---

2.2

The mirrors will pivot to project the laser onto the DICE-TRANSPARENT-COVER (MT1-001645) . A square pattern will appear, composed of 4 colors: **white/violet**, **blue**, **red**, and **green**.

Check: The 4 colors appear clearly and are distinct (no blending).

Check: The **green** and **red** colors must be projected onto **Tilt #1**.



2.3

<1> Gobos are tested from 1 to 256.

Check that the dotted lines are well-defined and that the beam does not tremble.

<2> Afterwards, the sequence is repeated.

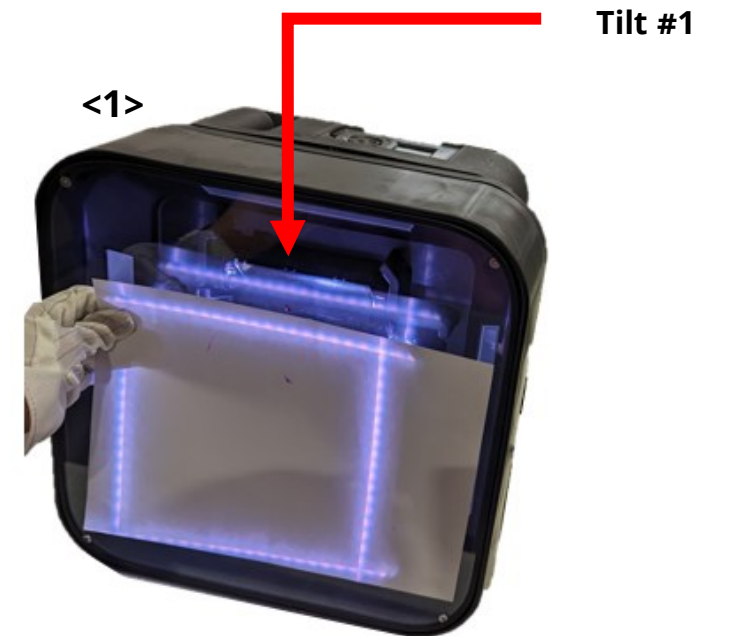

TEST 3: Test Tilt		Tools/Equipment: TrueCon1 cable
		CAUTION! Class 3R laser procedure. Avoid direct eye exposure.
Test purpose		Test and verify the operation of the laser module (Gobo and colorimetry).
	Instructions	Diagram
3.1	<p><1> Make sure that the DICE-TRANSPARENT-COVER (MT1-001645) is in place.</p> <p><2> Plug the power cable and turn the fixture ON.</p> <p><3> Press the knob near the screen panel of the fixture and go to Service> Autorun> Test Tilt.</p>	
3.2	<p><1> At the beginning of the test, the 4 Tilts perform a reset to be placed in its 0 position (frost side facing the tower) (A).</p>	

Test Tilt sequence:

- a. Beginning in 0 position

Smooth movement

- b. 360° inward rotation.
- c. 270° outward rotation,
Frost side upwards (A).
- d. 90° inward rotation,
0 position.
- e. 90° inward rotation,
Frost side upwards (A).
- f. X2 360° outward rotation,
Frost side upwards (A).

Speed movement(repeated three times)

- g. 225° outward rotation.
- h. 45° inward rotation.
- i. 180° outward rotation.
- j. 90° inward rotation.
- k. Back to 0 position.

*The blue arrow is only indicative of an outward movement, and the yellow arrow is only to indicate an inwards movement.

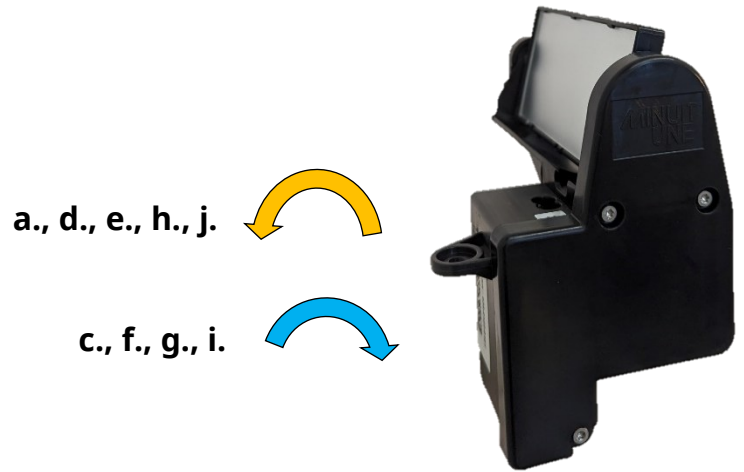

3.3

3.4

After the sequence has ended, verify that the four Tilts have returned correctly to their 0 position (step 3.2 in this same procedure).

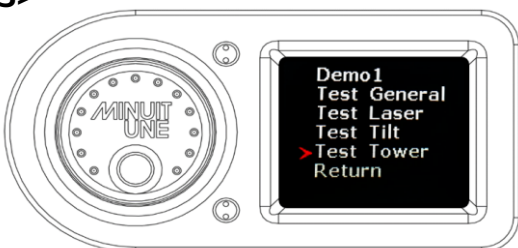
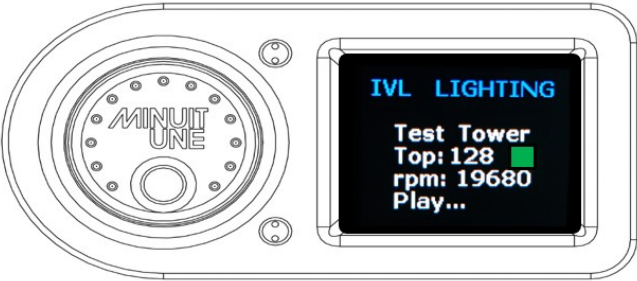
TEST 4: Test Tower		Tools/Equipment: TrueCon1 cable
		CAUTION! Class 3R laser procedure. Avoid direct eye exposure.
Test purpose	Test the functionality of the DICE-CENTRAL-TOWER-ASSEMBLY(MT1-002787) by verifying the sensor reading and the central motor's speed.	
	Instructions	Diagram
4.1	<p><1> Make sure that the DICE-TRANSPARENT-COVER (MT1-001645) is in place.</p> <p><2> Plug the power cable and turn the fixture ON.</p> <p><3> Press the knob near the screen panel of the fixture and go to Service> Autorun> Test Tower.</p>	<p><2></p>  <p><3></p> 
4.2	<p>On the 'Test Tower' screen the following parameters will be found:</p> <p>Top: <i>Sensor reading should be 128</i> ■</p> <p><i>Square indicator should be green.</i></p> <p>rpm: <i>It should have a reading higher than 19000, corresponding to 330 Hz.</i></p>	

4.3

<1> A few seconds after launching the **Test Tower** a red LED (**A**) will light up, indicating that the module is functioning correctly (correct speed and sensor reading), and therefore, the system's security will be activated.

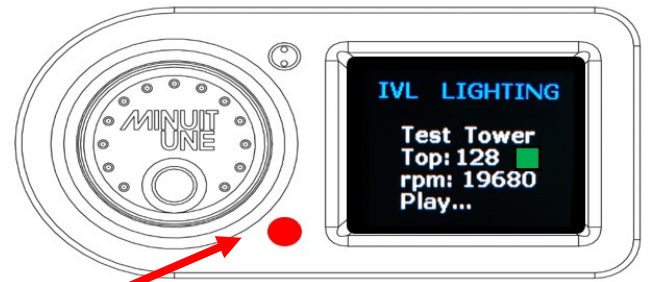

A

Speed > 19000 rmp

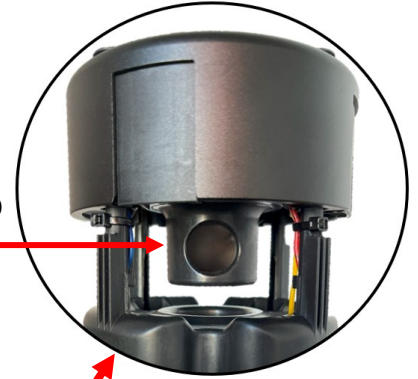

<2> Click the knob to stop the test.

4.4



Important to consider during this test:

- The module should not be making a loud noise beyond the normal range.
- The motor should not be trembling.
- If the red LED has not activated, it means that the module has some issue.
- Top sensor should have a reading of 128 The square indicator must be green if it is red the sensor is not having a good reading and, it can result in an abnormal gobo projection.

If an anomaly is detected, please contact the Minuit Une team for technical assistance.

SOFTWARE UPDATE

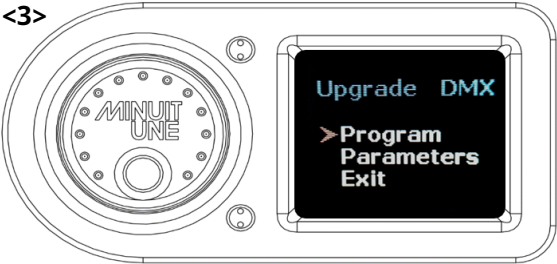
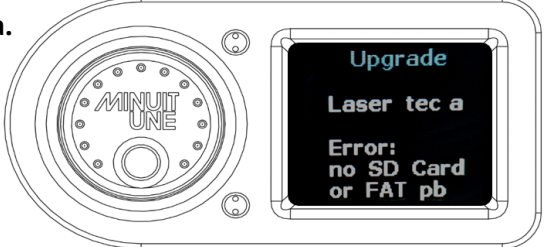
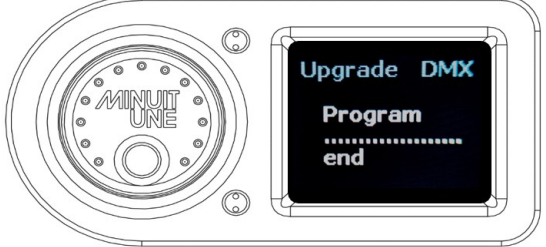
SOF 1: SOFTWARE UPDATE DMX UPGRADE	Tools needed: -TrueCon1 cable. -SD CARD. -.bin files.	
	CAUTION! Class 3R laser procedure. Avoid direct eye exposure.	
Purpose	Improve the system's performance ,add, replace, modify product functions. *Software update is required after replacing a module to ensure compatibility with the systems.	
	Instructions	Diagram
1.1	<p><1> Contact the Minit Une technical team to obtain the files for the latest available software version.</p> <p><2> Place the files shared by the team on an empty SD card.</p> <p>Note: <i>Do not change or modify the file names, as the system will not recognize them.</i></p>	
1.2	<p>Before connecting the PowerCon cable to the product to power it up:</p> <p>Insert the SD card into the top of the MOTHER-PCB-ASSEMBLY (MT1-002691).</p> <p>Make sure the SD card is well inserted.</p>	<p>SD CARD</p>
1.3	<p><1> Before connecting the PowerCon to the fixture, press the knob without releasing.</p> <p><2> Connect the PowerCon cable (turn on the product), while keeping the knob pressed. A green LED (A) will blink. Release the button when it stops blinking.</p>	

<p><3> The screen lights up and should display the 'UPGRADE DMX' screen. If not, turn it off and repeat the previous operation.</p>	 <p><2></p>  <p><3></p>
<p>1.4</p> <p><1> On the UPGRADE DMX screen, select "Program."</p> <p>a. <u>If the screen displays ERROR: No SD Card, check if the SD card is inserted in the correct orientation or properly seated.</u></p> <p>< 2 > The program upload starts; wait for "end" to be displayed.</p> <p><3> Still on the UPGRADE DMX screen, select "Exit".</p> <p>< 4 > The fixture does a reset.</p> <p><5> Turn off the Product and follow the second part of the update SOF 2: (Modules update procedure) here below.</p>	<p>a.</p>  <p><2></p>  <p><3></p> 

**SOF 2:
SOFTWARE UPDATE
MODULES UPGRADE**

⚠ CAUTION!
Class 3R laser procedure. Avoid direct eye exposure.

Purpose Improve the system's performance ,add, replace, modify module functions.
*Software update is required after replacing a module to ensure compatibility with the systems.

2.1

<1> Make sure the SD card is still inserted and the product is **off**.

<2> Connect the PowerCon cable (turn on the product).

<3> As soon as the Minuit Une logo appears on the screen, press the knob without releasing it while keeping the knob pressed. A green LED (A) will blink. Release the button when it stops blinking.

<4> After releasing the knob a settings screen should appear. If not, turn it off and repeat the previous operation.



2.3

<1> On the settings screen, select "**All**" to Update all the modules(spare parts).

a. In the case that you have replaced a module, you can select only the update for the replaced module.

b. If the screen displays ERROR: No SD Card, check if the SD card is inserted in the correct orientation or properly seated.

<2> The program upload starts; wait for "end" to be displayed.

<3> Still on the settings screen, select "**Exit**".

<4> The fixture does a reset.

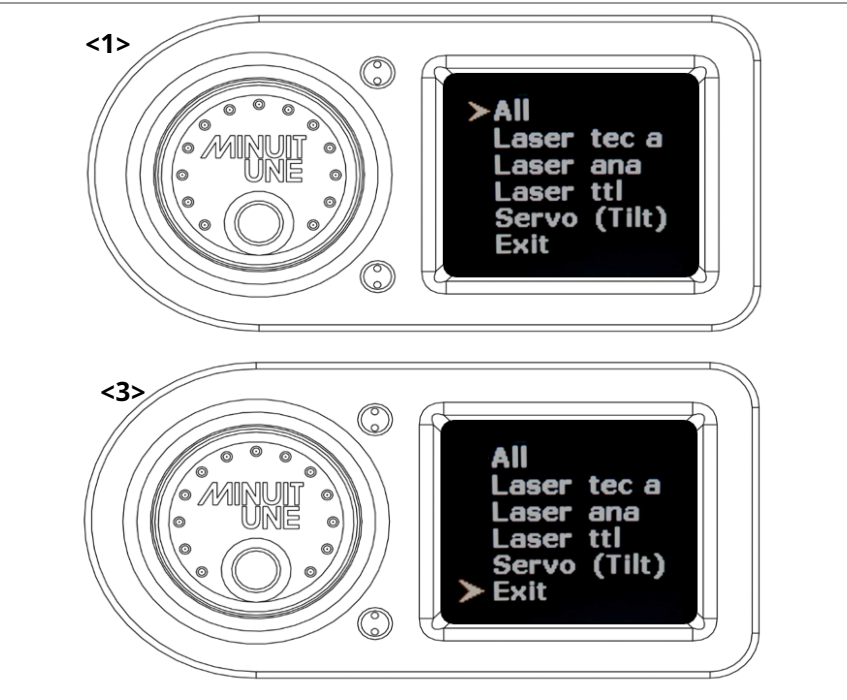

2.4

<1>After DMX and Modules Update verify if the software is well updated.
In the main menu go to **About...:**

The software version is shown:
Software **VX.X**

<1>

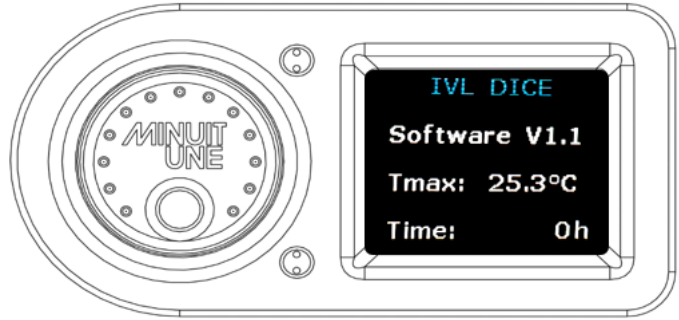

<2>Then press again to have de software version of the modules.

The software version is shown:
TEC **VX.X**
Ana. **VX.X**
TTL **VX.X**
Servo. **VX.X**

<2>

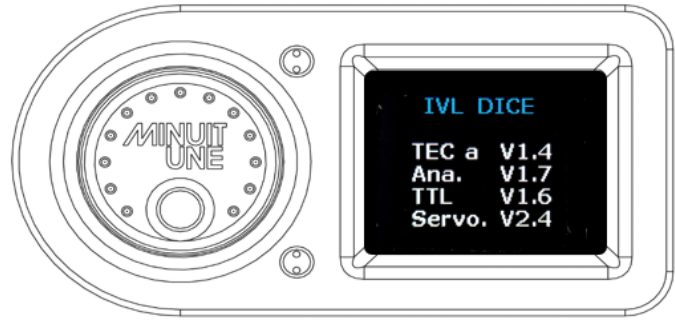

CLEANING



Excessive dust, smoke fluid, and particle degrades performance, causes overheating, and will damage the product.

This product is intended to be use in haze environment for maximizing effect. The use of good haze machine with neutral fluid like MDG ATMe is recommended to maximize lifetime of the product. On the contrary the use of oilbased smoke machine is to avoid and will cause damage to the product on long term.





Warranty will be void if oil trace is found in the product. Damage caused by inadequate cleaning or maintenance is not covered by the product warranty.

The product should be cleaned regularly to obtain maximum performance and brightness.

The frequency of cleaning depends on the environmental factor where the product is used. We advise you to do visual check on the Plexiglas shape after each use of the product to determine if cleaning is necessary.

<p>CLE 1: DICE-TRANSPARENT-COVER (MT1-001645)</p>	<p>Tools/Equipment:</p> <ul style="list-style-type: none"> - A microfiber cloth. - A non-alcoholic glass cleaner or water. 	
<div style="background-color: yellow; padding: 10px; border: 1px solid black;"> <div style="display: flex; justify-content: space-between; align-items: center;">  <div style="text-align: center;"> <p>DANGER</p> <p><small>ALWAYS TURN OFF AND DISCONNECT THE PRODUCT BEFORE OPENING THE PRODUCT OR PERFORMING THIS DESCRIBED SERVICE PROCEDURE. DANGEROUS CLASS 4 LASER RADIATION POTENTIALLY ACCESSIBLE IF THESE INSTRUCTIONS ARE NOT FOLLOWED WHICH COULD RESULT IN SEVERE EYE OR SKIN INJURY.</small></p> </div>  </div> </div>		
	<p>Instructions</p>	<p>Diagram</p>
<p>1.1</p>	<p><1> Remove the DICE TRANSPARENT-COVER(MT1-001645) (REP 4:).</p> <p><2> Before cleaning, ensure that there are no particles on the surface of the MT1-001645, as they could scratch it during the cleaning process.</p> <p>Tip: Use a compressor to give it a burst of air and remove the particles.</p>	

<p>1.2</p>	<p><1> Clean both sides, internal and external of the DICE-TRANSPARENT-COVER (MT1-001645) on a soft support with a very gentle movement.</p> <p>Always clean the DICE-TRANSPARENT-COVER(MT1-001645) with:</p> <ul style="list-style-type: none"> A. A soft and lint-free wipe. B. A standard PH neutral glass cleaner without alcohol can be used to clean the grease left by the smoke machine fluid. <p><i>Do not use products, solvents, or abrasive materials for cleaning the MT1-001645. This can deform the properties of the material.</i></p>	
------------	--	---

<p>CLE 2: LATERAL-BELT-ACTUATOR-ASSEMBLY (MT1-000935) MASK-MIRROR-AND-FROST- ASSEMBLY (MT1-002639)</p>	<p>Tools/Equipment:</p>	<ul style="list-style-type: none"> - A microfiber cloth. - A non-alcoholic glass cleaner. 	
<div style="background-color: yellow; padding: 10px; border: 1px solid black;">  <p style="text-align: center;">DANGER ALWAYS TURN OFF AND DISCONNECT THE PRODUCT BEFORE OPENING THE PRODUCT OR PERFORMING THIS DESCRIBED SERVICE PROCEDURE. DANGEROUS CLASS 4 LASER RADIATION POTENTIALLY ACCESSIBLE IF THESE INSTRUCTIONS ARE NOT FOLLOWED WHICH COULD RESULT IN SEVERE EYE OR SKIN INJURY.</p>  </div>			
	<p>Instructions</p>	<p>Diagram</p>	
<p>2.1</p>	<p><1> Remove the DICE TRANSPARENT-COVER(MT1-001645) (REP 4:).</p> <p><2> Clean the MT1-000935 (A) mirror and (B) frost side with a soft wipe and / or standard glass cleaner.</p> <p><3> Dry the previously cleaned surface with a no wet clean cloth to avoid leaving streaks.</p>	 <p style="text-align: center;">A</p>  <p style="text-align: center;">B</p>	
<p>2.2</p>	<p>Clean the MASK-MIRROR-AND-FROST-ASSEMBLY (MT1-002639) including its 4 (A) frosted surfaces with a wet microfiber cloth and let it dry.</p>	 <p style="text-align: center;">A</p>	

With a (A) soft cotton swab soaked with glass cleaner, clean the two diodes.

It is important to prevent particles from obstructing these diodes and keep them clean, as this could affect the sensor's reading.





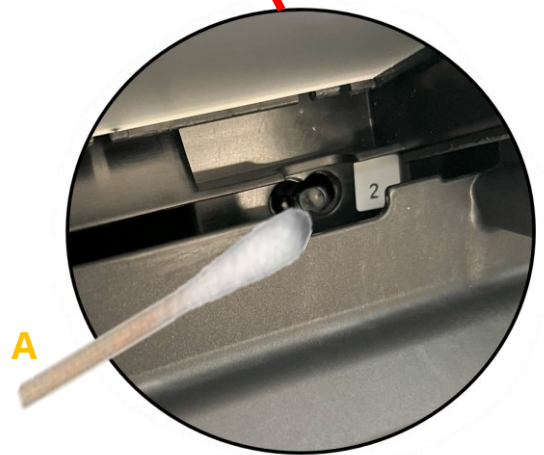
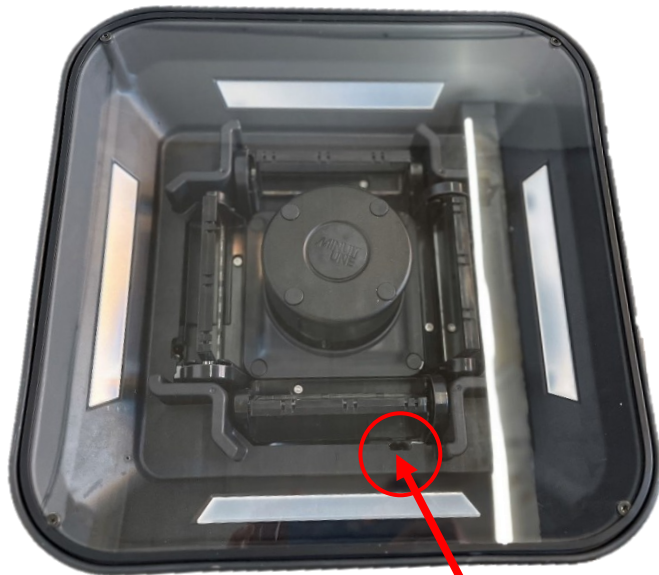

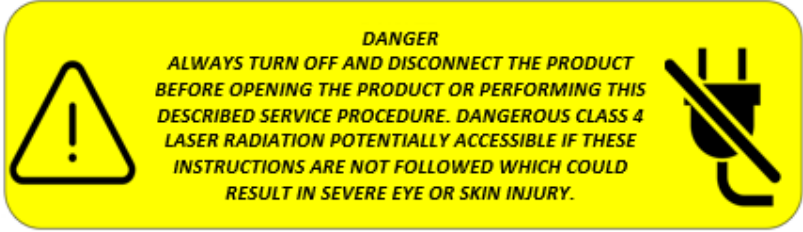
2.3

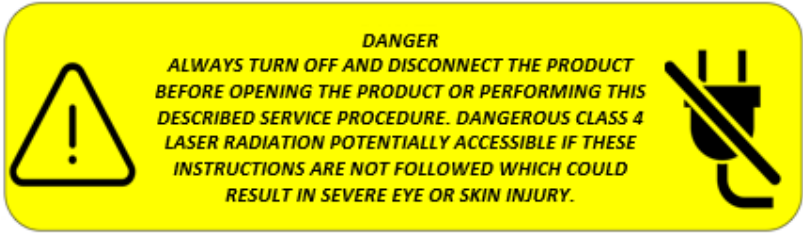
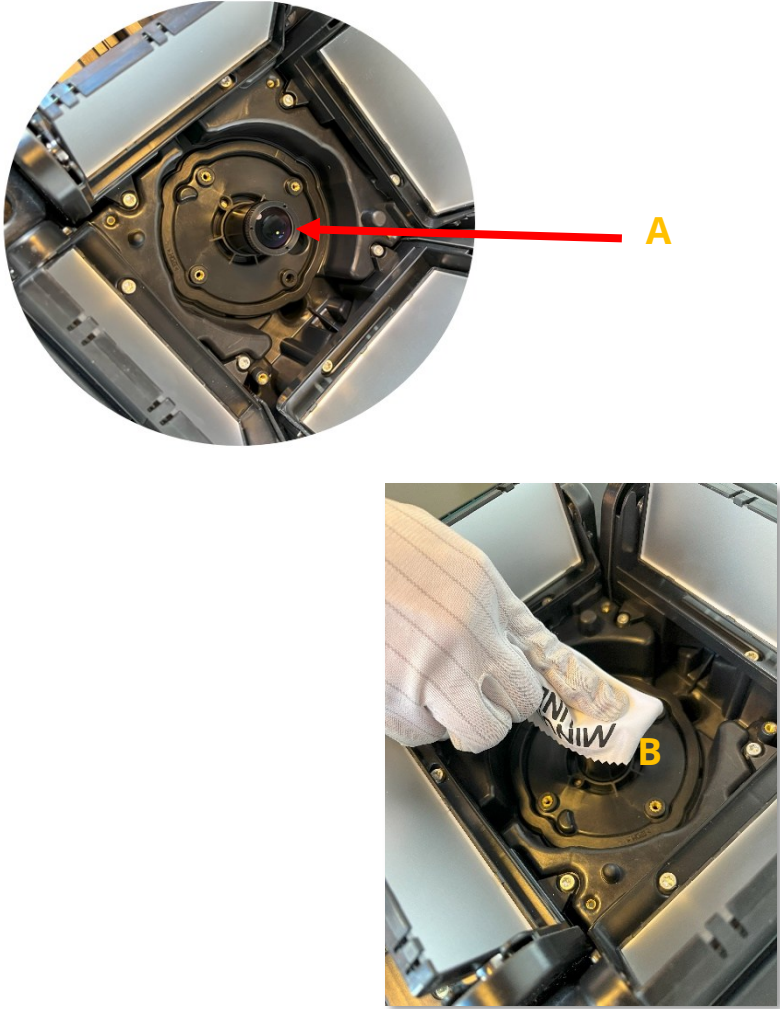
*These diodes are responsible for detecting whether the **MT1-000935** is on the mirror side or the frost side.*

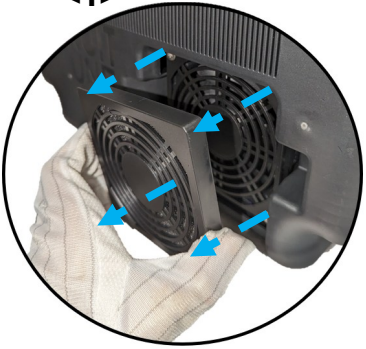

<p>CLE 3: DICE-CENTRAL-TOWER-ASSEMBLY (MT1-002787)</p>	<p>Tools/Equipment:</p> <ul style="list-style-type: none"> - Cotton swab. - Microfiber cloth. - Isopropyl alcohol. 	
		
	<p>Instructions</p>	<p>Diagram</p>
<p>3.1</p>	<p><1> Gently clean the Scanning Mirror and the glass with a soft cotton swab-soaked (A) with iso alcohol (B) and / or drag a soft lens tissue or microfiber cloth (C) on the mirror.</p> <p><2> Dry the previously cleaned surface with a no wet clean cloth to avoid leaving streaks.</p> <p>TIP: Cleaning the optics of the MT1-002787 helps to preserve the sharpness of the laser projection.</p>	

<p>CLE 4: FIBER-LASER-COLLIMATOR (MT1-002474)</p>	<p>Tools/Equipment:</p> <ul style="list-style-type: none"> - Microfiber cloth. - Isopropyl alcohol. 	
		
	<p>Instructions</p>	<p>Diagram</p>
<p>3.1</p>	<p><1> Gently clean the collimator’s lens (A) with a microfiber cloth (B) soaked with iso alcohol .</p> <p><2> Softly dry the collimator’s lens previously cleaned surface with a no wet clean cloth to avoid leaving streaks.</p>	

<p>CLE 5: Ventilation system FILTER-COVER(MT1-002406), FILTER(MT1-002405), FAN(MT1-001921) and HEATSINK.</p>	<p>Tools/Equipment:</p> <ul style="list-style-type: none"> -Cotton swab. -Micro fiber cloth. -Dish soap. -Warm water. -All-purpose cleaner. 	
<div style="background-color: yellow; padding: 10px; border: 1px solid black;"> <div style="display: flex; justify-content: space-between; align-items: center;">  <div style="text-align: center;"> <p>DANGER</p> <p><small>ALWAYS TURN OFF AND DISCONNECT THE PRODUCT BEFORE OPENING THE PRODUCT OR PERFORMING THIS DESCRIBED SERVICE PROCEDURE. DANGEROUS CLASS 4 LASER RADIATION POTENTIALLY ACCESSIBLE IF THESE INSTRUCTIONS ARE NOT FOLLOWED WHICH COULD RESULT IN SEVERE EYE OR SKIN INJURY.</small></p> </div>  </div> </div>		
	<p>Instructions</p>	<p>Diagram</p>
<p>5.1</p>	<p><i>If the fan filter and the fan are not cleaned regularly, airflow could be obstructed and will cause overheating which will degrade performance and could cause damage to the product.</i></p>	<div style="display: flex; align-items: center; justify-content: center;">  <p>BE CAREFUL WITH HEATSINK Wait for a cooling down before cleaning.</p> </div>
<p>5.2</p>	<p><1> To clean the FILTER(MT1-002405) and the FILTER-COVER (MT1-002406), you need to remove the MT1-002406 by hand.</p> <p><2> The filter is inserted into the filter cover.</p>	<div style="text-align: center;">  <div style="display: flex; justify-content: space-around; margin-top: 20px;"> <div style="text-align: center;"> <p><1></p>  </div> <div style="text-align: center;"> <p><2></p>  </div> </div> </div>

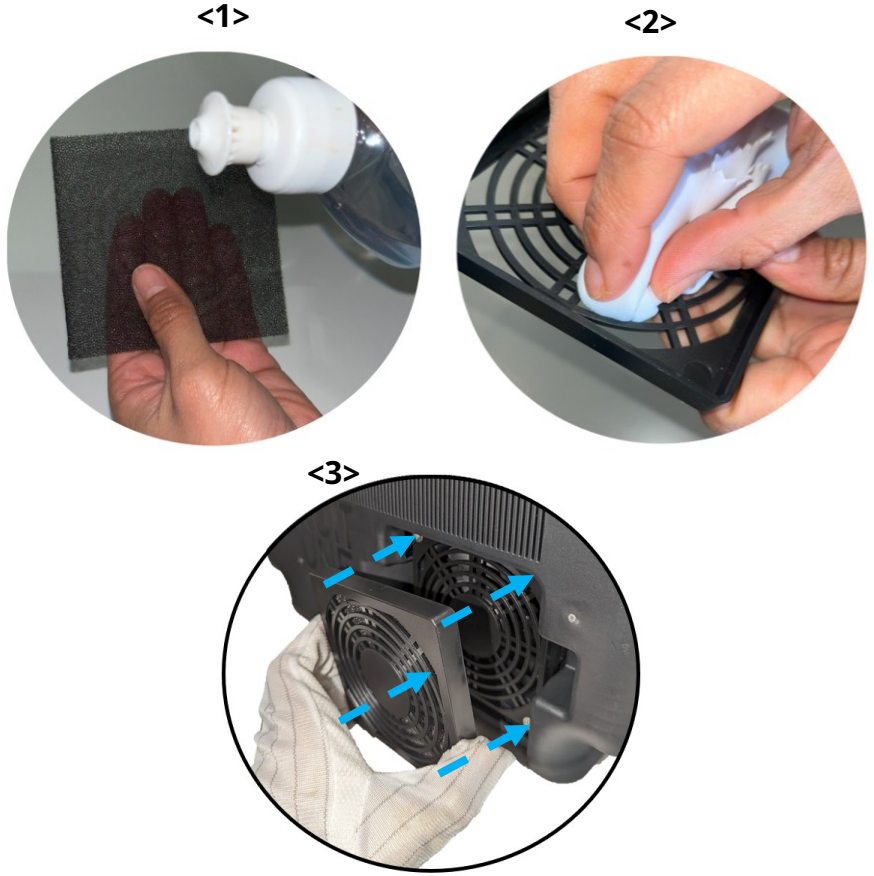
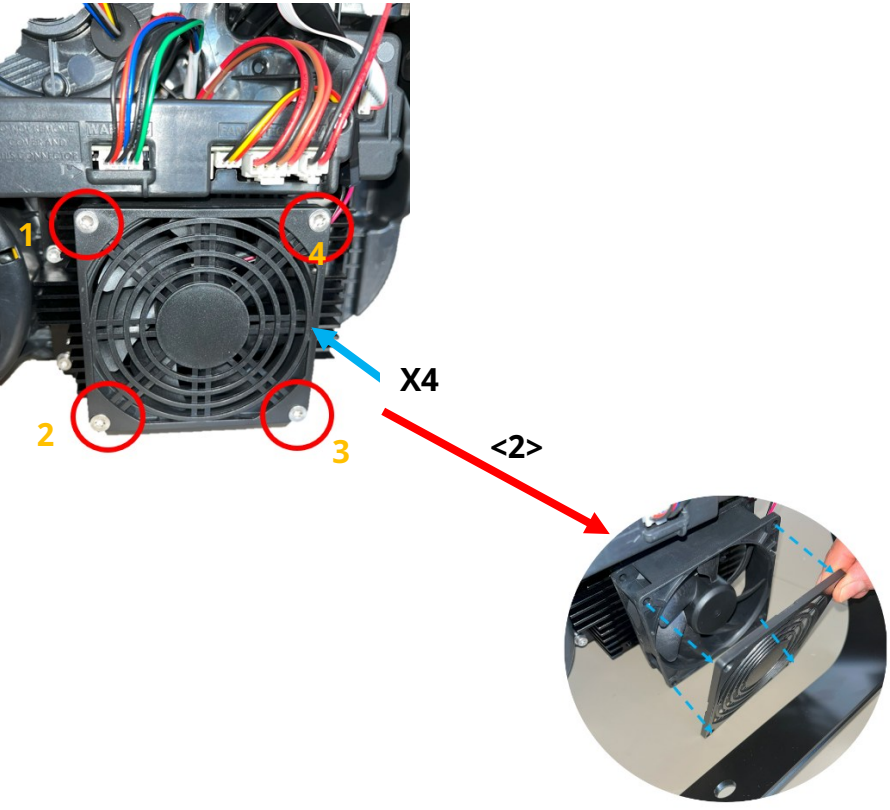
<p>5.3</p>	<p><1> To clean the FILTER(MT1-002405) as well as the FILTER-COVER (MT1-002406), wash them with warm water and dish soap. Let them dry completely before putting it back.</p> <p><2> The MT1-002406 can also be cleaned with a microfiber cloth and all-purpose cleaner.</p> <p><3> When putting back the filter with the filter cover, ensure that all sides are properly inserted.</p>	
<p>5.4</p>	<p><1> To clean the FAN(MT1-001921) blades ,Remove the DICE-BOTTOM-HOUSING-AND-INSERTS (MT1-002461) (REP 1:).</p> <p><2> Unscrew the 4 screws M4-40-FLAT-HEAD-TORX (MT1-002408) on the FINGER-GUARD(MT1-002404). Clean the MT1-002404, if necessary, with all-purpose cleaner.</p>	

<p>5.5</p>	<p><1> Unscrew the FAN (MT1-001921) to clean de blades in both sides with a microfiber cloth or cotton swab and an all-purpose-cleaner.</p> <p><2> <i>If the fan's connector has been disconnected to clean it easily, pay attention to connect and position back the FAN(MT1-019210) correctly to maintain the airflow.</i></p>	
<p>5.6</p>	<p><1> Use a cotton swab or a microfiber cloth to remove the accumulation of grease and dust in the HEATSINK.</p> <p><2> Clean the HEATSINK with a wet microfiber cloth and let it dry.</p>	

5.7

<1> Use a cotton swab to remove an accumulation of greasy dust trapped in the slots (A) of the **DICE-BOTTOM-HOUSING-AND-INSERTS**(MT1-002461).

<2> Clean the (MT1-002461) with a wet microfiber cloth and let it dry.

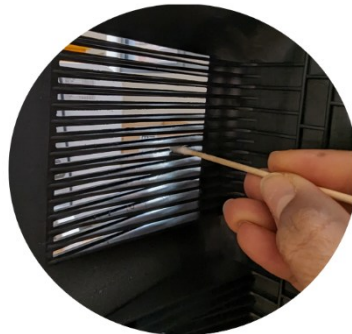

<1>



<2>

DMX Protocol

Ch. Mode 1	Ch. Mode 2	Function	Sub-Function	Percent Value	DMX Value	Default Value (%)	Remarks
1	1	Control	OFF	0 > 9	0 > 23	100%	
			Reset Motor	10 > 14	24 > 36		
			Reset Source	15 > 20	37 > 51		
			FULL Reset	21 > 25	52 > 64		
			ON – Fast Mode	26 > 49	65 > 125		
			ON – Standard Mode	50 > 100	126 > 255		
2	2	Shutter Frequency	Open	0 > 5	0 > 14	0%	
			Closed	6 > 10	15 > 27		
			30 > 1440 BPM	11 > 89	28 > 227		
			Open	90 > 100	228 > 255		
3	3	Shutter Duration	Short > Long	0 > 100	0 > 255	50%	The strobe duration – Closer to 0% will be short bursts of light. Closer to 100% will be longer bursts of light.
4	4	Number of Beams (E-Gobo Type)	1 Beam	0 > 10	0 > 27	0%	
			2 Beams	11 > 21	28 > 55		
			4 Beams	22 > 33	56 > 83		
			8 Beams	34 > 43	84 > 111		
			16 Beams	44 > 54	112 > 139		
			32 Beams	55 > 65	140 > 167		
			64 Beams	66 > 76	168 > 195		
			128 Beams	77 > 87	196 > 223		
			256 Beams	88 > 100	224 > 255		
5	5	Index / Offset (E-Gobo Index)	Index 0° > 360°	0 > 100	0 > 255	0%	
6	6	Index / Offset FINE (E-Gobo Index)	Index 0° > 360°	0 > 100	0 > 65535		
7	7	Rotation (E-Gobo Rotation)	Stop ROT (Index Active)	0 > 4.90	0 > 12	0%	When ROTATION is active, the Index parameter is NOT Active.
			CW ROT (Fast → Slow)	4.91 > 48.04	13 > 122		
			Relative STOP (Index NOT Active)	48.05 > 52.35	123 > 133		
			CCW ROT (Slow → Fast)	52.36 > 95.10	134 > 242		
			Stop ROT (Index Active)	95.11 > 100	243 > 255		
8	8	Beam Size (E-Gobo Size)	0° > 360°	0 > 100	0 > 255	100%	100% = Full light plan visual 0% = No light plan visual
9	9	Beam Size FINE (E-Gobo Size)	0° > 360°	0 > 100	0 > 65535		
10	10	TILT 1	-180° > 180°	0 > 100	0 > 255	50%	
11	11	TILT 1 FINE	-180° > 180°	0 > 100	0 > 65535		
12	12	Dimmer 1A	Close > Open	0 > 100	0 > 255	0%	

	13	Dimmer 1B	Close > Open	0 > 100	0 > 255	0%	
13	14	RED 1A	0 > FF	0 > 100	0 > 255	100%	
	15	RED 1B	0 > FF	0 > 100	0 > 255	100%	
14	16	GREEN 1A	0 > FF	0 > 100	0 > 255	100%	
	17	GREEN 1B	0 > FF	0 > 100	0 > 255	100%	
15	18	BLUE 1A	0 > FF	0 > 100	0 > 255	100%	
	19	BLUE 1B	0 > FF	0 > 100	0 > 255	100%	
16	20	TILT 2	-180° > 180°	0 > 100	0 > 255	50%	
17	21	TILT 2 FINE	-180° > 180°	0 > 100	0 > 65535		
18	22	Dimmer 2A	Close > Open	0 > 100	0 > 255	0%	
	23	Dimmer 2B	Close > Open	0 > 100	0 > 255	0%	
19	24	RED 2A	0 > FF	0 > 100	0 > 255	100%	
	25	RED 2B	0 > FF	0 > 100	0 > 255	100%	
20	26	GREEN 2A	0 > FF	0 > 100	0 > 255	100%	
	27	GREEN 2B	0 > FF	0 > 100	0 > 255	100%	
21	28	BLUE 2A	0 > FF	0 > 100	0 > 255	100%	
	29	BLUE 2B	0 > FF	0 > 100	0 > 255	100%	
22	30	TILT 3	-180° > 180°	0 > 100	0 > 255	50%	
23	31	TILT 3 FINE	-180° > 180°	0 > 100	0 > 65535		
24	32	Dimmer 3A	Close > Open	0 > 100	0 > 255	0%	
	33	Dimmer 3B	Close > Open	0 > 100	0 > 255	0%	
25	34	RED 3A	0 > FF	0 > 100	0 > 255	100%	
	35	RED 3B	0 > FF	0 > 100	0 > 255	100%	
26	36	GREEN 3A	0 > FF	0 > 100	0 > 255	100%	
	37	GREEN 3B	0 > FF	0 > 100	0 > 255	100%	
27	38	BLUE 3A	0 > FF	0 > 100	0 > 255	100%	
	39	BLUE 3B	0 > FF	0 > 100	0 > 255	100%	
28	40	TILT 4	-180° > 180°	0 > 100	0 > 255	50%	
29	41	TILT 4 FINE	-180° > 180°	0 > 100	0 > 65535		
30	42	Dimmer 4A	Close > Open	0 > 100	0 > 255	0%	
	43	Dimmer 4B	Close > Open	0 > 100	0 > 255	0%	
31	44	RED 4A	0 > FF	0 > 100	0 > 255	100%	
	45	RED 4B	0 > FF	0 > 100	0 > 255	100%	
32	46	GREEN 4A	0 > FF	0 > 100	0 > 255	100%	
	47	GREEN 4B	0 > FF	0 > 100	0 > 255	100%	
33	48	BLUE 4A	0 > FF	0 > 100	0 > 255	100%	
	49	BLUE 4B	0 > FF	0 > 100	0 > 255	100%	

Specification

Measurements and weight

All dimensions are given in millimetres.

Dimensions of the housing: 384 x 384 x 238 mm³

Total dimensions of the fixture (adjustable yoke included): 384 x 433 x 238 mm³

Weight: 10,6kg

Housing / Construction

Modular conception: conception subdivided into modules, which can be independently and quickly replaced.

Protection rating: IP20

Menu display: LCD colour screen

Low cleaning care: optical parts isolated from haze.

Light Source

Class 3R laser product: extended source

Wavelength: 450nm,520nm,635m

Colours: smooth RGB spectrum

Nominal Beam diameter (1/e) at scanning vertex: 17±1mm

Beam divergence: $\geq 1.8\text{mrad}$

Nominal Scan rate: 330Hz

Distance from scanning vertex to closest point of human access (NPHA): 155mm.

Maximum output: 38 μJ .

Central scanning system

Scanning motor: extensive lifetime brushless motor

Scanning angle: 360°

Mirror: R>98%

Safeguard: certified failed-safe

Mirror output

Mirror side of the tilt: 115 x 50 mm²

4 independent mirrors: producing independent 4 light planes.

Aperture by mirror: 84° linear aperture by tilt

Operating angle: 105°

Motorization: 4 stepper motors – 16 bits non-linear resolution

Movement: very smooth at low speed and extremely reactive

Maximum speed: from mirror to frost side in 0,25sec.

Frost output

Frost side of the tilt: 115 x 50 mm² frost filter

4 independent frost filter: producing 4 independent frosted outputs.

Aperture by mirror: very wide

Operating angle: 105°

Motorization: 4 stepper motors – 16 bits non-linear resolution

Movement: very smooth at low speed and extremely reactive

Maximum speed: from mirror to frost side in 0,25sec.

DMX

Number of channels in mode 1: 33

Number of channels in mode 2: 49

2 options: standard or fast mode

Update: by micro-SD card
 Electronical gobos: 9 e-gobos
 RGB control: independent RGB control per tilt
 Dimmer control: independent dimmer control per tilt
 Strobe: control over the frequency of the pulse and the duration of the pulse

Beam Control (e-gobos)

Number of beams: 1 to 256
 Control: intuitive gobo like system
 Gobo type: number of beams
 Gobo size: width of the beam
 Gobo indexation: position of the beam
 Gobo rotation: speed and direction of the beam

Power supply

Power supply unit: 100 to 240 Volts – 50/60Hz
 Power: 200 Watt maximum

Cooling system/Thermal

Cooling: thermo electric cooling
 Safety: protection against excessive temperatures
 Nominal operating temperature of the laser source: +25°C

Installation

Adjustable mounting yoke: rigging clamps attachment point.
 Position: on a vertical rigging structure, adjustable mounting yoke horizontal to the ground
 Safety: safety cable through the adjustable mounting yoke

Operating temperature

Maximum ambient temperature: +40°C (+104°F)
 Minimum ambient temperature: +0°C (+32°F)

Connections

AC power input/output: Neutrik PowerCon True1
 DMX data in/out : 5-pin locking XLR.

Standards:

SAFETY:

CB IEC60825-1:2014
 21CFR 1040
 ANSI Z136.1
 CB IEC62368-1 :2018

EMC:

EN55032 :2015+A11 :2020+A1 :2020
 EN55035 :2017+A11 :2020
 EN IEC 61000-3-2 :2019+A1 :2021
 EN 61000-3-3:2013+A1 :2019+A2 :2021
 47CFR Part 15 Subpart B
 ICES-003 :Issue 7october 2020
 J55032(H29)
 AS/NZS CISPR32, :2015+A12020



	<p>Disposing of this product</p> <p>IVL products are supplied in compliance with Directive 2012/19/EC of the European Parliament and of the Council of the European Union on WEEE (Waste Electrical and Electronic Equipment), where applicable.</p> <p>Help preserve the environment! Ensure that this product is recycled at the end of its life. Your supplier can give details of local arrangements for the disposal of IVL products.</p>
--	---

Service Return Form

Your contact

Company :

First Name Last Name

Addressee
.....
.....
.....

Country City

Telephone..... Email

Your product

Model:..... Serial Number :.....

Buying date:..... Invoice number:.....

Failure Reference (reference in the Troubleshooting)
.....

Failure description (please add photo or video to illustrate your problem):
.....
.....
.....

Defective part:

Instructions to follow

- 0) In case of failure, please first contact Minuit Une to find a solution
- 1) If necessary and asked by Minuit Une, send back the defective part correctly packed with this sheet correctly filled in.
- 2) Return fees are at your charge.
- 3) If covered by the warranty, a new part will be sent to you for free.
- 4) If not covered by the warranty, an invoice will be sent to you for the new part and for its shipping.